

WISOL / WSSF10R1AT

DATA SHEET Rev.12



WISOL

531-7, Gajang-ro, Osan-si, Gyeonggi-do
Rep. of Korea

<http://www.wisol.co.kr>

▶ CONTENTS

1. Approval Revision Record	3
2. Scope	4
3. Numbering of product	4
3-1. Product	4
3-2. Part No.	4
3-3. Lot. No.	5
4. Absolute Maximum Ratings	6
5. DC Characteristics	6
6. I/O Specifications	6
7. RF Specifications	7
8. Pin Description	8
8-1. Interface PIN(SMD Type : 31 Pin)_Bottom view	8
8-2. Interface PIN description	9
9. Block Diagram	10
10. Dimensions & drawing	11
10-1. Design dimension.....	11
10-2. Soldering Footprint.....	12
11. Reflow profile	13
12. Package	14
12-1. Dimension of Tape.....	14
12-2. Dimension of Reel.....	14
12-3. IN BOX	15
12-4. OUT BOX	15
13. Power Modes	16
13-1. TX current test.....	16
13-2. RX current test	16
13-3. Sleep current test	17
13-4. Deep sleep current test	17

1. Approval Revision Record

NO	REASON	RECORD OF REVISION	Date	Remark
1	REV00	WSSFM100A00 Approval Releases	2016-07-13	-
2	REV01	PCB Design changed - PCB Size - PIN-map	2016-08-22	-
3	REV02	PCB Design changed - PIN-map	2016-08-25	-
4	REV03	Model name changed	2016-10-05	-
5	REV04	Package Spec. added	2016-10-17	-
6	REV05	PIN function & Reflow profile added	2016-10-30	-
7	REV06	RF spec.(Harmonics, Sensitivity) changed	2016-10-31	-
8	REV07	Sentence added.	2016-11-15	-
9	REV08	RF spec. changed & Power mode added.	2016-12-02	-
10	REV09	Power mode Test method changed.	2016-12-20	-
11	REV10	Add VCC condition for VIL and VIH	2016-12-22	-
12	REV11	Add Soldering footprint	2017-01-15	-
13	REV12	PIN27 note. Removed.	2017-03-20	-

2. Scope

Description : Sigfox Module RCZ1

Type : SMD Type

PCBA Size : 13mm(W) x 15mm(L) x 2.21mm(H)

This module is SIGFOX verified and that the ETSI are completed.

3. Numbering of product

3-1. Product



3-2. Part No.

W	S	S	F	M	1	0	R	1	A	T
(1)	(2)	(3)	(4)	(5)	(6)	(7)	(8)	(9)	(10)	(11)

No.	EXPLANATION
(1),(2)	WISOL
(3),(4)	Application (SF:Sigfox)
(5)	Type (M:Module)
(6),(7)	Group model numbering
(8), (9)	Region Code
(10),(11)	Application Type(Firm Ware Type) AT(AT command version) AP(API version)

3-3. Lot. No.

S	A	C	J	A	1	0	0	1
(1)	(2)	(3)	(4)	(5)	(6)	(7)	(8)	(9)

①	Sigfox Module																																																																																			
②	Manufacture Area <table border="1" style="width: 100%; text-align: center; border-collapse: collapse;"> <tr> <td style="width: 25%;">Packing Lot</td> <td style="width: 25%;">A</td> <td style="width: 25%;">B</td> <td style="width: 25%;">C</td> </tr> <tr style="background-color: #f4a460;"> <td>Area</td> <td>Korea</td> <td>China</td> <td>Vietnam</td> </tr> </table>												Packing Lot	A	B	C	Area	Korea	China	Vietnam																																																																
Packing Lot	A	B	C																																																																																	
Area	Korea	China	Vietnam																																																																																	
③	Year <table border="1" style="width: 100%; text-align: center; border-collapse: collapse;"> <tr style="background-color: #d3d3d3;"> <td style="width: 10%;">Year</td> <td style="width: 8.3%;">2010</td> <td style="width: 8.3%;">2011</td> <td style="width: 8.3%;">2012</td> <td style="width: 8.3%;">2013</td> <td style="width: 8.3%;">2014</td> <td style="width: 8.3%;">2015</td> <td style="width: 8.3%;">2016</td> <td style="width: 8.3%;">2017</td> <td style="width: 8.3%;">2018</td> <td style="width: 8.3%;">2019</td> </tr> <tr> <td>Mark</td> <td>W</td> <td>X</td> <td>Y</td> <td>Z</td> <td>A</td> <td>B</td> <td>C</td> <td>D</td> <td>E</td> <td>F</td> </tr> </table>												Year	2010	2011	2012	2013	2014	2015	2016	2017	2018	2019	Mark	W	X	Y	Z	A	B	C	D	E	F																																																		
Year	2010	2011	2012	2013	2014	2015	2016	2017	2018	2019																																																																										
Mark	W	X	Y	Z	A	B	C	D	E	F																																																																										
④	Month <table border="1" style="width: 100%; text-align: center; border-collapse: collapse;"> <tr style="background-color: #d3d3d3;"> <td style="width: 10%;">Month</td> <td style="width: 8.3%;">1</td> <td style="width: 8.3%;">2</td> <td style="width: 8.3%;">3</td> <td style="width: 8.3%;">4</td> <td style="width: 8.3%;">5</td> <td style="width: 8.3%;">6</td> <td style="width: 8.3%;">7</td> <td style="width: 8.3%;">8</td> <td style="width: 8.3%;">9</td> <td style="width: 8.3%;">10</td> <td style="width: 8.3%;">11</td> <td style="width: 8.3%;">12</td> </tr> <tr> <td>Mark</td> <td>A</td> <td>B</td> <td>C</td> <td>D</td> <td>E</td> <td>F</td> <td>G</td> <td>H</td> <td>I</td> <td>J</td> <td>K</td> <td>L</td> </tr> </table>												Month	1	2	3	4	5	6	7	8	9	10	11	12	Mark	A	B	C	D	E	F	G	H	I	J	K	L																																														
Month	1	2	3	4	5	6	7	8	9	10	11	12																																																																								
Mark	A	B	C	D	E	F	G	H	I	J	K	L																																																																								
⑤	Day <table border="1" style="width: 100%; text-align: center; border-collapse: collapse;"> <tr style="background-color: #d3d3d3;"> <td style="width: 10%;">Day</td> <td style="width: 8.3%;">1</td> <td style="width: 8.3%;">2</td> <td style="width: 8.3%;">3</td> <td style="width: 8.3%;">4</td> <td style="width: 8.3%;">5</td> <td style="width: 8.3%;">6</td> <td style="width: 8.3%;">7</td> <td style="width: 8.3%;">8</td> <td style="width: 8.3%;">9</td> <td style="width: 8.3%;">10</td> <td style="width: 8.3%;"></td> </tr> <tr> <td>Mark</td> <td>1</td> <td>2</td> <td>3</td> <td>4</td> <td>5</td> <td>6</td> <td>7</td> <td>8</td> <td>9</td> <td>A</td> <td></td> </tr> <tr style="background-color: #d3d3d3;"> <td style="width: 10%;">Day</td> <td style="width: 8.3%;">11</td> <td style="width: 8.3%;">12</td> <td style="width: 8.3%;">13</td> <td style="width: 8.3%;">14</td> <td style="width: 8.3%;">15</td> <td style="width: 8.3%;">16</td> <td style="width: 8.3%;">17</td> <td style="width: 8.3%;">18</td> <td style="width: 8.3%;">19</td> <td style="width: 8.3%;">20</td> <td style="width: 8.3%;"></td> </tr> <tr> <td>Mark</td> <td>B</td> <td>C</td> <td>D</td> <td>E</td> <td>F</td> <td>G</td> <td>H</td> <td>I</td> <td>J</td> <td>K</td> <td></td> </tr> <tr style="background-color: #d3d3d3;"> <td style="width: 10%;">Day</td> <td style="width: 8.3%;">21</td> <td style="width: 8.3%;">22</td> <td style="width: 8.3%;">23</td> <td style="width: 8.3%;">24</td> <td style="width: 8.3%;">25</td> <td style="width: 8.3%;">26</td> <td style="width: 8.3%;">27</td> <td style="width: 8.3%;">28</td> <td style="width: 8.3%;">29</td> <td style="width: 8.3%;">30</td> <td style="width: 8.3%;">31</td> </tr> <tr> <td>Mark</td> <td>L</td> <td>M</td> <td>N</td> <td>O</td> <td>P</td> <td>Q</td> <td>R</td> <td>S</td> <td>T</td> <td>U</td> <td>V</td> </tr> </table>												Day	1	2	3	4	5	6	7	8	9	10		Mark	1	2	3	4	5	6	7	8	9	A		Day	11	12	13	14	15	16	17	18	19	20		Mark	B	C	D	E	F	G	H	I	J	K		Day	21	22	23	24	25	26	27	28	29	30	31	Mark	L	M	N	O	P	Q	R	S	T	U	V
Day	1	2	3	4	5	6	7	8	9	10																																																																										
Mark	1	2	3	4	5	6	7	8	9	A																																																																										
Day	11	12	13	14	15	16	17	18	19	20																																																																										
Mark	B	C	D	E	F	G	H	I	J	K																																																																										
Day	21	22	23	24	25	26	27	28	29	30	31																																																																									
Mark	L	M	N	O	P	Q	R	S	T	U	V																																																																									
⑥⑦	Model Serial Number (10,11,12,13...)																																																																																			
⑧⑨	A Serial Number (1serial: 1,100ea)																																																																																			

4. Absolute Maximum Ratings

Symbol	Parameter	Rating	Unit
VCC	Module input voltage	-0.5 to 5.5	V
OT	Operating Temperature	-30 to +85	°C
ST	Storage Temperature	-40 to +125	°C

5. DC Characteristics

Symbol	Parameter	Min	Typ.	Max	Unit
VCC	Module input voltage	1.8	3.3	3.6	V
Current	Tx Current(@”15”setting,MOD)	-	65	-	mA
	Tx Current(@”14”setting,MOD)	-	54	-	mA
	Rx Current	-	15	-	mA
	Sleep Current	-	2	-	uA

6. I/O Specifications

Symbol	Parameter	Min	Typ.	Max	Unit
VIH	High level input voltage @VCC=3.3V	2.0			V
VIL	Low level input voltage @CC=3.3V			0.8	V

7. RF Specifications

Conditions: VCC=3.3V, Temp=25°C

Parameter		Min	Typ.	Max	Unit
RF Characteristics					
RF Frequency	Tx		868.130		MHz
	Rx		869.525		MHz
Tx output power(at "15" setting)		12.5	13.5	15.5	dBm
Tx output power(at "14" setting)		11.5	12.5	14.5	dBm
Frequency Error Tolerance(+25°C)		-2.5	-	+2.5	ppm
2 nd Harmonics(conducted)		-	-37	-35	dBm
3 rd Harmonics(conducted)		-	-41	-35	dBm
Rx Sensitivity(@600bps, GFSK)		-127	-		dBm
Rx Spurious Emission(30MHz~12.75GHz)				-54	dBm

* Because of output power variation of modules the maximum output power can be over 14dBm, so we recommend to set 14 as default output setting.

8. Pin Description

8-1. Interface PIN(SMD Type : 31 Pin)_Bottom view

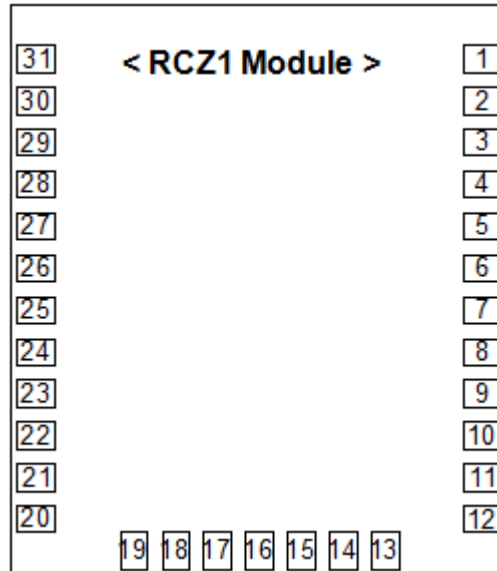

1	GND	9	GPIO5	17	TXLED/ DBG_CLK	25	GPIO2
2	GND	10	GPIO4	18	NC4/DBG_EN	26	GPIO3
3	GND	11	CPU_LED	19	RST_N	27	GND
4	GND	12	RADIO_LED	20	GND	28	GND
5	NC3/ SYSCCLK	13	GPIO9	21	VDD_IO	29	GND
6	GPIO8	14	UARTTX	22	GND	30	RF_IO
7	GPIO7	15	UARTRX	23	GPIO0	31	GND
8	GPIO6	16	RXLED/ DBG_DATA	24	GPIO1		

Pin-map of RCZ1, RCZ2, RCZ3 and RCZ4 module is compatible (Pin to Pin)

8-2. Interface PIN description

PIN(s)	NAME	TYPE	Description
1~4	GND	P	Ground
5	NC3/SYSCLK	N	Do not connect
6	GPIO8	I/O/PU	General purpose IO
7	GPIO7	I/O/PU	General purpose IO, selectable SPI functionality (MISO)
8	GPIO6	I/O/PU	General purpose IO, selectable SPI functionality (MOSI)
9	GPIO5	I/O/PU	General purpose IO, selectable SPI functionality (SCK)
10	GPIO4	I/O/PU	General purpose IO, selectable $\Sigma\Delta$ DAC functionality, selectable dock functionality
11	CPU_LED	O	CPU activity indicator
12	RADIO_LED	O	Radio activity indicator
13	GPIO9	I/O/PU	General purpose IO, wakeup from deep sleep
14	UARTTX	O	UART transmit
15	UARTRX	I/PU	UART receive
16	RXLED/DBG_DATA	O	Receive activity indicator
17	TXLED/DBG_CLK	O	Transmit activity indicator
18	NC4/DBG_EN	PD	Do not connect
19	RST_N	I/PU	Optional reset pin
20	GND	P	Ground
21	VDD_IO	P	Power supply
22	GND	P	Ground
23	GPIO0	I/O/A/PU	General purpose IO, selectable ADC functionality, selectable $\Sigma\Delta$ DAC functionality, selectable clock functionality
24	GPIO1	I/O/A/PU	General purpose IO, selectable ADC functionality
25	GPIO2*	I/O/A/PU	General purpose IO, selectable ADC functionality
26	GPIO3*	I/O/A/PU	General purpose IO, selectable ADC functionality
27	GND	P	Ground
28~29	GND	P	Ground
30	RF_IO	A	RF input/output
31	GND	P	Ground

* The GPIO2 and GPIO3 pin as "Not connected" state if the product is designed to be compatible with RCZ2 and RCZ4 module.

9. Block Diagram

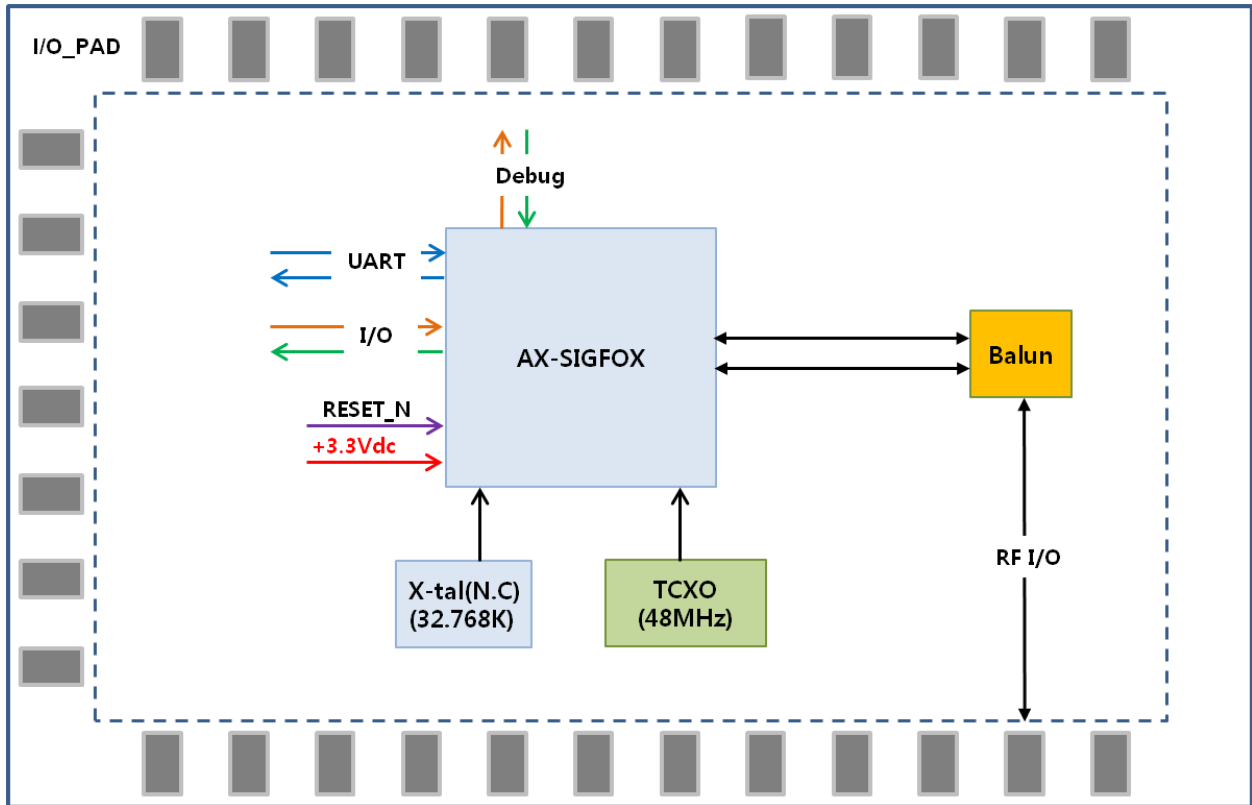

10. Dimensions & drawing

10-1. Design dimension

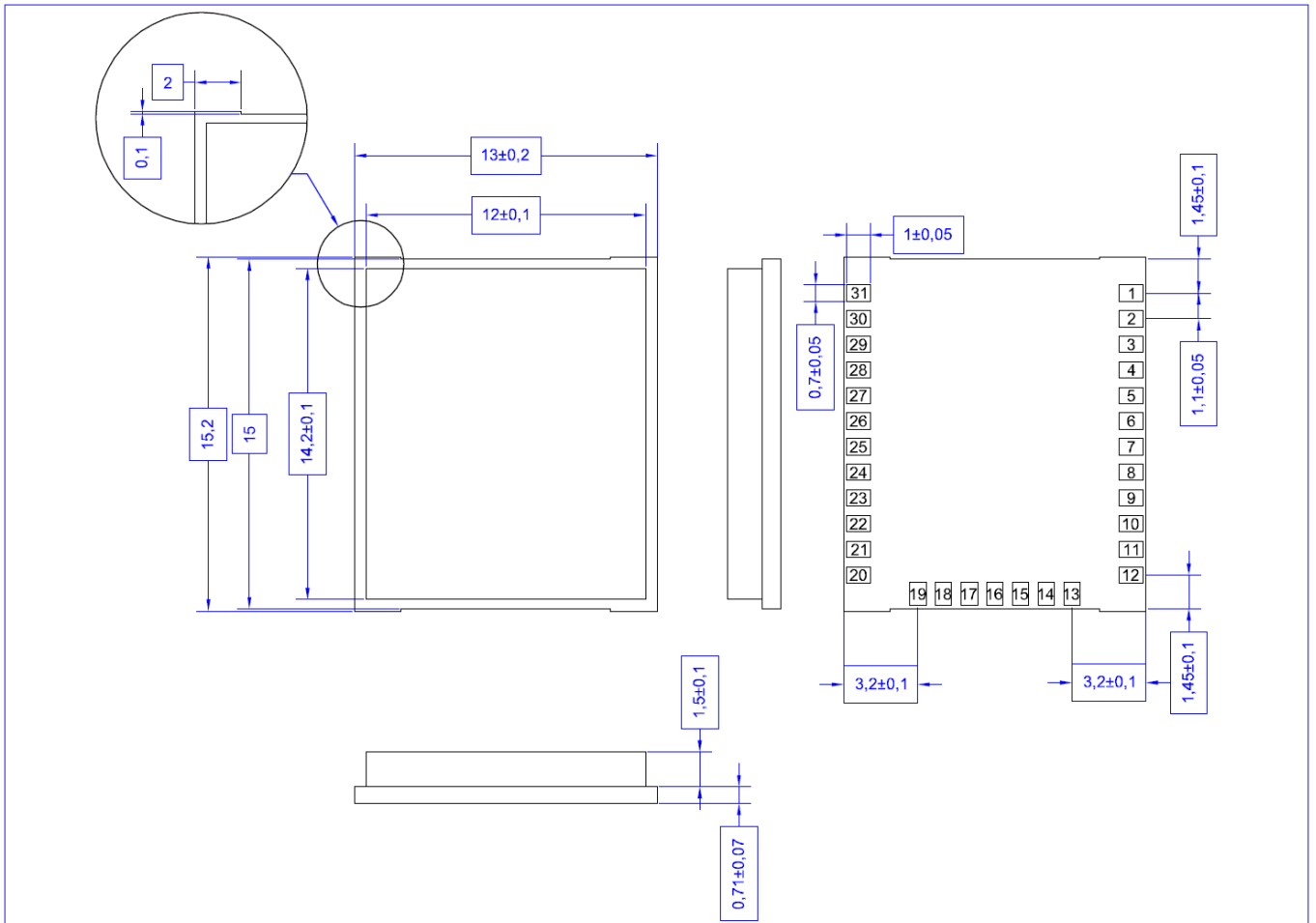

10-2. Soldering Footprint

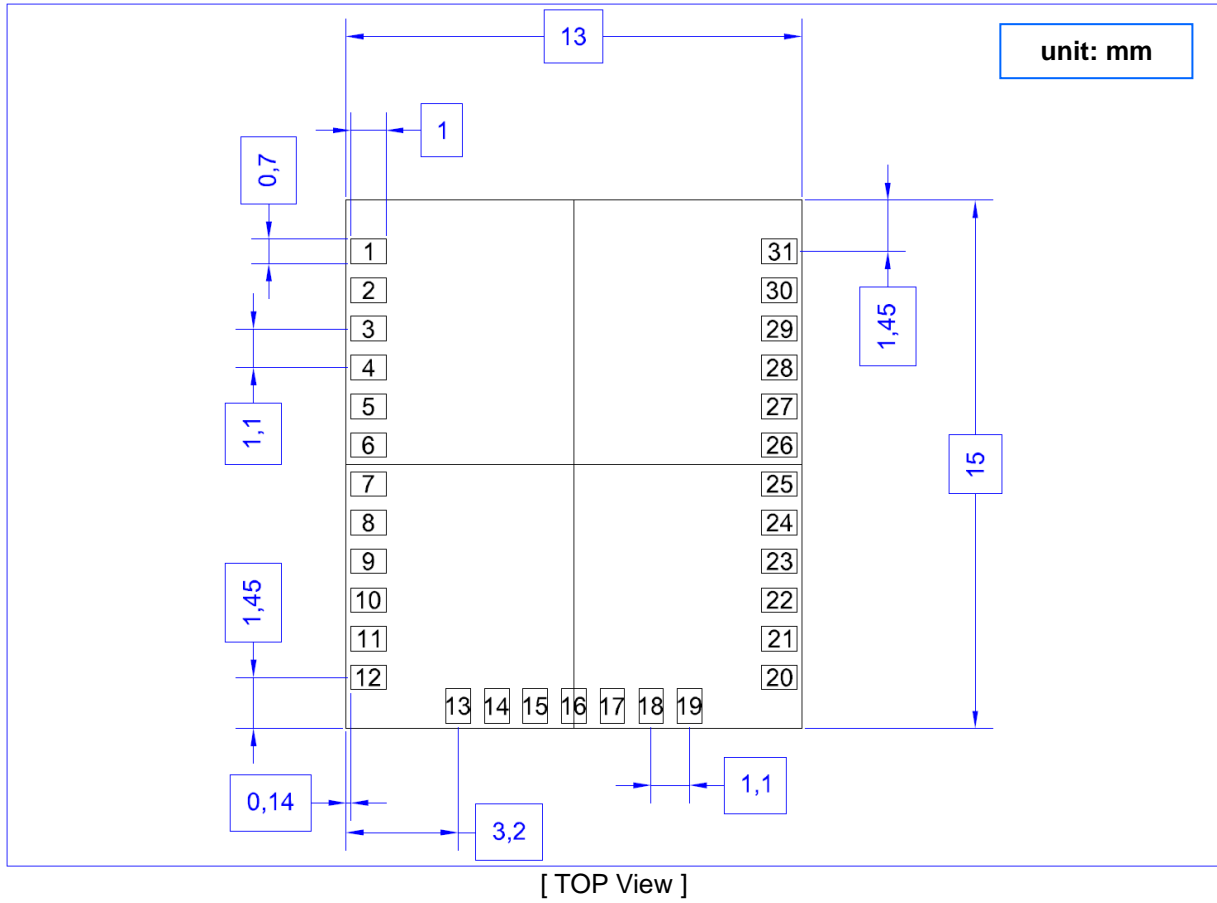

11. Reflow profile

<Reflow profile of Module>

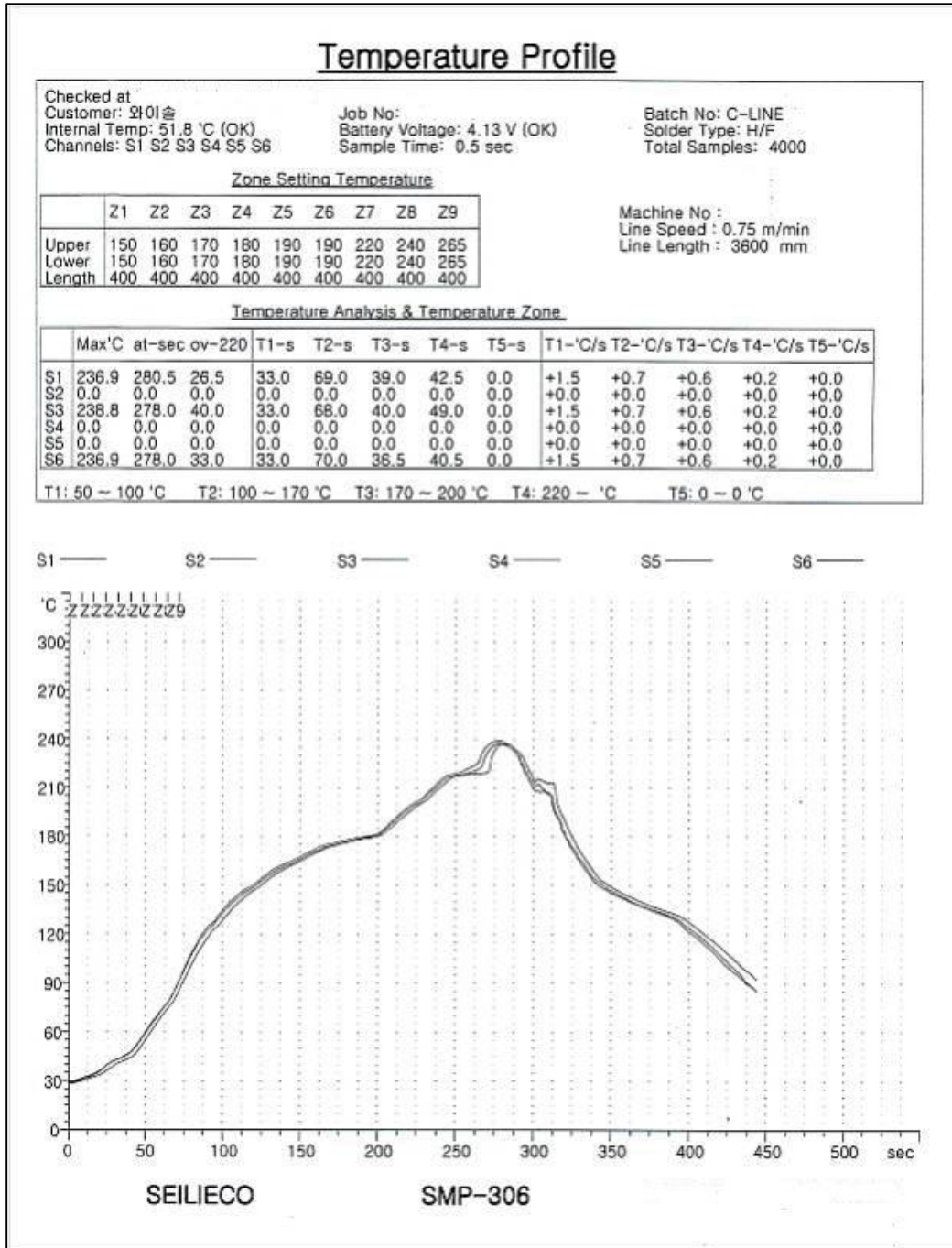

SPEC	Preheat	Soak	Ramp	PEAK
	50~100°C	100~170°C	220°C ↑	240°C
	1~2°C/sec	60~100sec	30~50sec	±5°C
result of measurement	1.5	69	44	237.5
	OK	OK	OK	OK

12-3. IN BOX

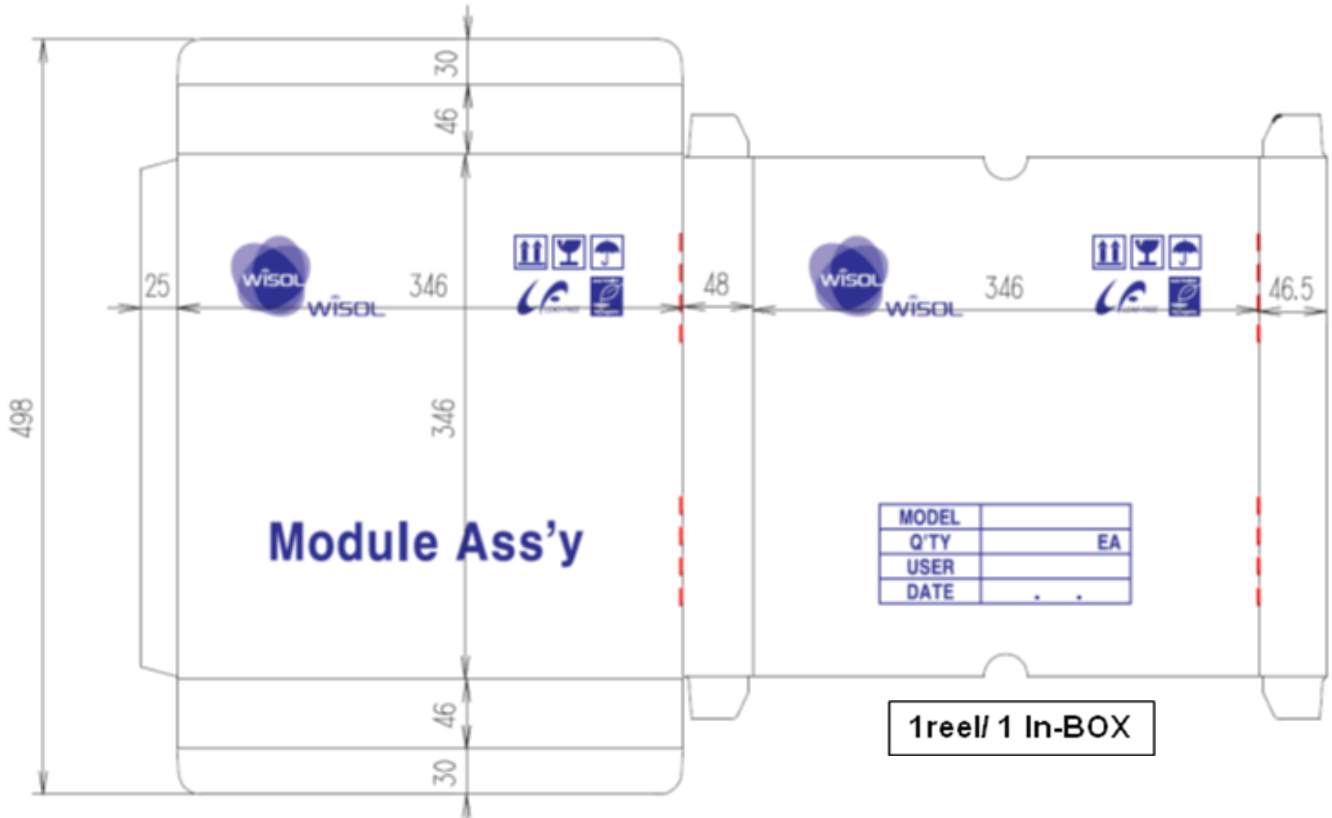

12-4. OUT BOX

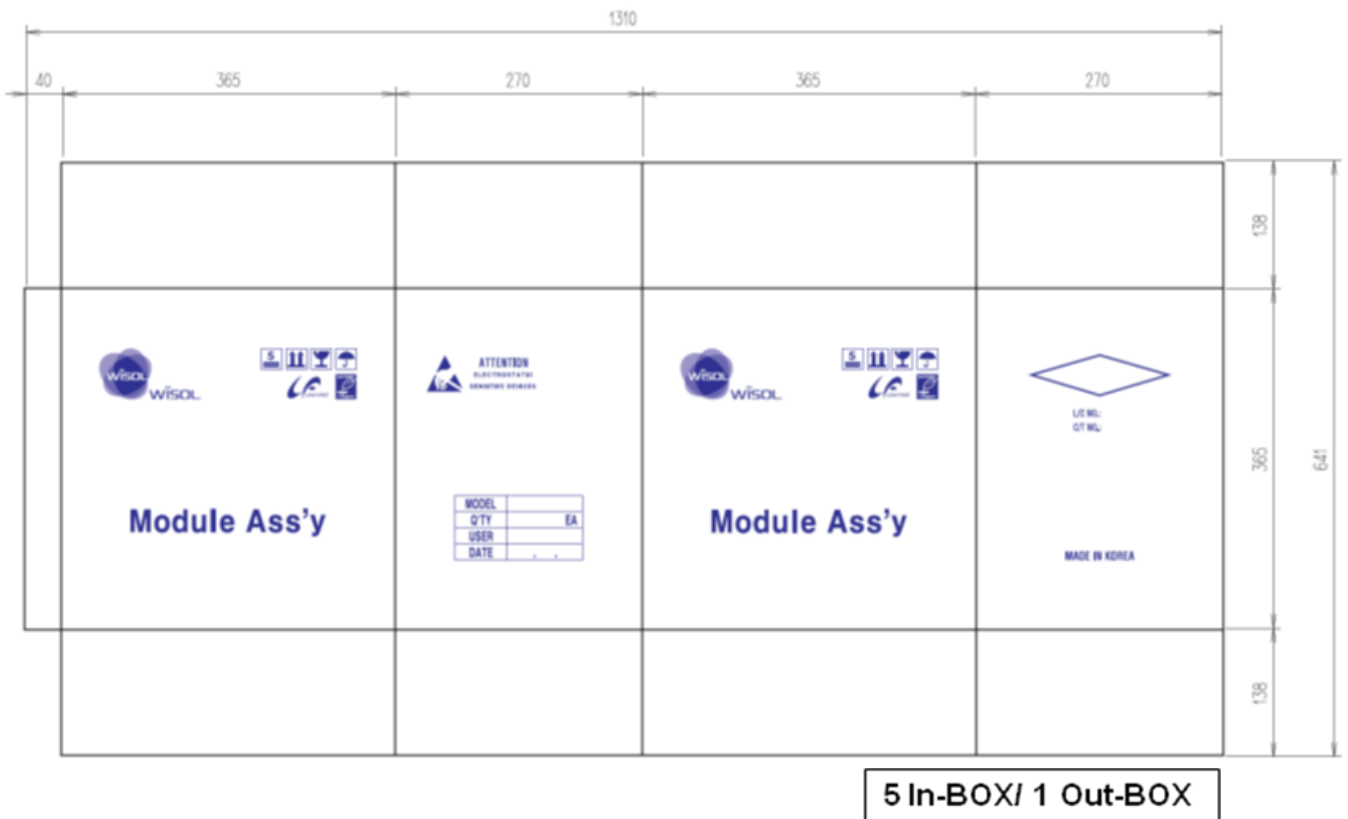

13. Power Modes

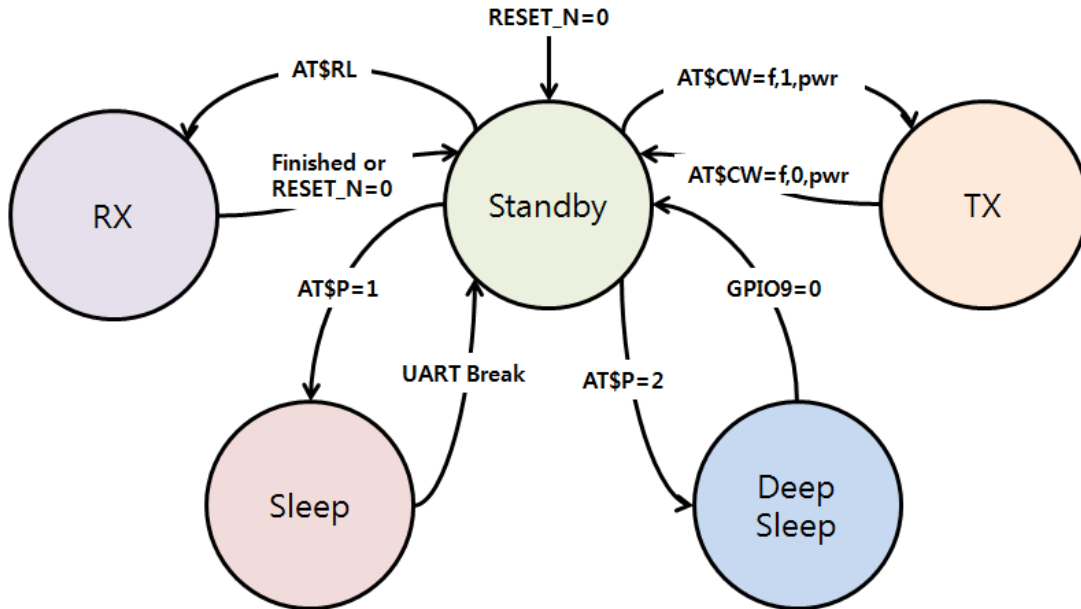

13-1. TX current test

1. Disconnect Debug Switch(SW5~SW9) on EVB
2. Connect UART Switch(SW10~SW11) on EVB
3. Power switch ON(SW4) on EVB
4. Push the RESET Switch(SW1) on EVB
5. Initial mode=Standby mode (@500uA/ Remove J2-CPULED jumper)
6. TX current test method
 - 1) Input AT command 'AT' (UART condition checking)
 - 2) Click the Quick command (MOD EU ON): default power table '15') or Input AT command 'AT\$IF=868130000 click 'Send' icon, then 'ATS302=15', click 'Send' icon, 'AT\$CB=-1,1' and then click 'Send' icon.
For changing RF power, use 'ATS302=XX' and then click 'Send' icon instead of using 'ATD302=15'
 - 3) Disconnect UART Switch(SW10~SW11) on EVB
 - 4) And then, Check TX current

13-2. RX current test

1. Disconnect Debug Switch(SW5~SW9) on EVB
2. Connect UART Switch(SW10~SW11) on EVB
3. Power switch ON(SW4) on EVB
4. Push the RESET Switch(SW1) on EVB
5. Initial mode=Standby mode (@500uA/ Remove J4-CPULED jumper)
3. RX current test method
 - 1) Input AT command 'AT' (UART condition checking)
 - 2) Input AT command 'AT\$RL' and then click 'Send' icon.
 - 3) Disconnect UART Switch(SW10~SW11) on EVB
 - 4) And then, Check TX current.

13-3. Sleep current test

1. Disconnect Debug Switch(SW5~SW9) on EVB
2. Connect UART Switch(SW10~SW11) on EVB
3. Power switch ON(SW4) on EVB
4. Push the RESET Switch(SW1) on EVB
5. Initial mode=idle mode (@500uA/ Remove J2-CPULED jumper)
6. Sleep current test method
 - 1) Input AT command 'AT' (UART condition checking)
 - 2) Input AT command 'AT\$P=1' (sleep mode command)
 - 3) Disconnect UART Switch(SW10~SW11) on EVB
 - 4) And then, Check Sleep current

13-4. Deep sleep current test

1. Disconnect Debug Switch(SW5~SW9) on EVB
2. Connect UART Switch(SW10~SW11) on EVB
3. Power switch ON(SW4) on EVB
4. Push the RESET Switch(SW1) on EVB
5. Initial mode=idle mode (@500uA/ Remove J2-CPULED jumper)
6. Sleep current test method
 - 1) Input AT command 'AT' (UART condition checking)
 - 2) Input AT command 'AT\$P=1' (sleep mode command)
 - 3) Disconnect UART Switch(SW10~SW11) on EVB
 - 4) And then, Check Sleep current
 - 5) If the module wakes up, Push the tact switch(SW2: wakeup PIN) on EVB