

# LSM100A User Manual

Rev 1.10

SJI

July. 3, 2023

## Contents

<b>1. HARD WARE.....</b>	<b>3</b>
1.1 EVALUATION KIT COMPONENT .....	3
1.2 EVB LSM100A BOARD .....	4
1.3 SCHEMATIC .....	5
1.4 CONNECTOR PIN DESCRIPTION .....	7
1.5 ANTENNA DIMENSION .....	8
1.6 RETURN LOSS & VSWR .....	9
1.7 2D RADIATION PATTERN.....	10
1.8 3D EFFICIENCY.....	11
1.9 EVB RADIATION → CONDUCTION CHANGE.....	12
<b>2. MEMORY MAP.....</b>	<b>13</b>
<b>3. TEST PROGRAM.....</b>	<b>14</b>
3.1 EVALUATION BOARD CONNECTION .....	14
3.2 PROGRAM EXECUTION .....	14
3.3 TEST PROGRAM DESCRIPTION .....	15
<b>4. AT COMMAND COMPLETE SET .....</b>	<b>20</b>
4.1 LORA COMMAND.....	20
4.2 SIGFOX COMMAND.....	27

## History

Date	Contents	Version	
2021-11-11	Create	V1.0	
2021-11-12	Insertion Hardware Description	V1.1	
2021-12-08	Remove monarch	V1.2	
2021-12-13	Apply Sigfox RC1 only	V1.3	
2021-12-15	Edit content	V1.4	
2021-12-22	Change content	V1.5	
2022-01-21	Add AT command, Add software version	V1.6	
2022-01-28	Add sigfox memory map	V1.7	
2022-04-25	Change AT Command GUI and Add AT command - Add AT\$RP2P, AT\$SP2P command in Sigfox - Add AT+NWKTYPE command in LoRa	V1.8	
2022-05-16	Change AT Command GUI and Add AT command - Add AT+PCONF, AT+PSEND, AT+PRECV command in LoRa Change memory map(add IAP, expansion F/W area)	V1.9	
2023-06-30	Change RC(sigfox band) Change AS923-1 command - standard (AT+BAND=0,1) - japan (AT+BAND=0,4)	V1.10	

## 1. Hard Ware

### 1.1 Evaluation Kit Component

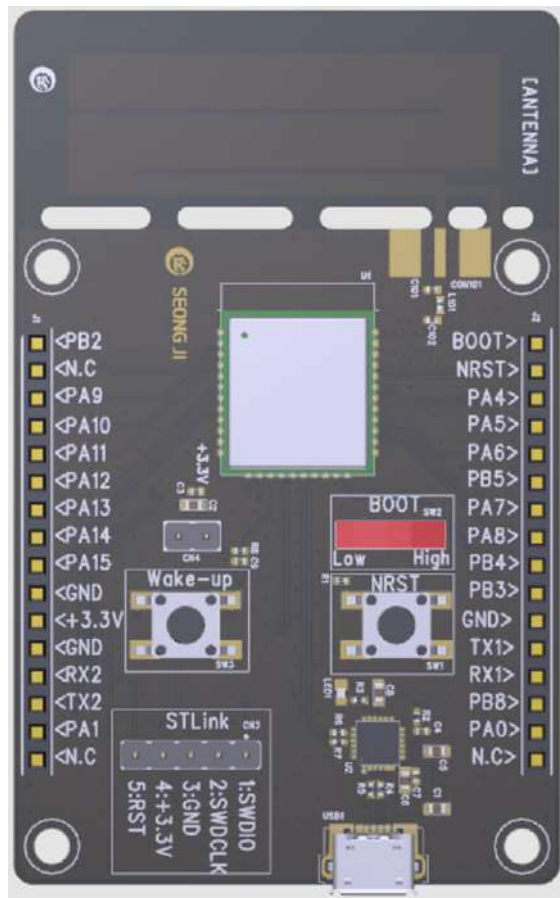

**EVB LSM**

[ Fig. Evaluation Kit Component ]

#### LSM100A Evaluation Kit Component

- 1) EVB LSM: 1EA
- 2) SMA Connector(ST type): 1EA

## 1.2 EVB LSM100A Board

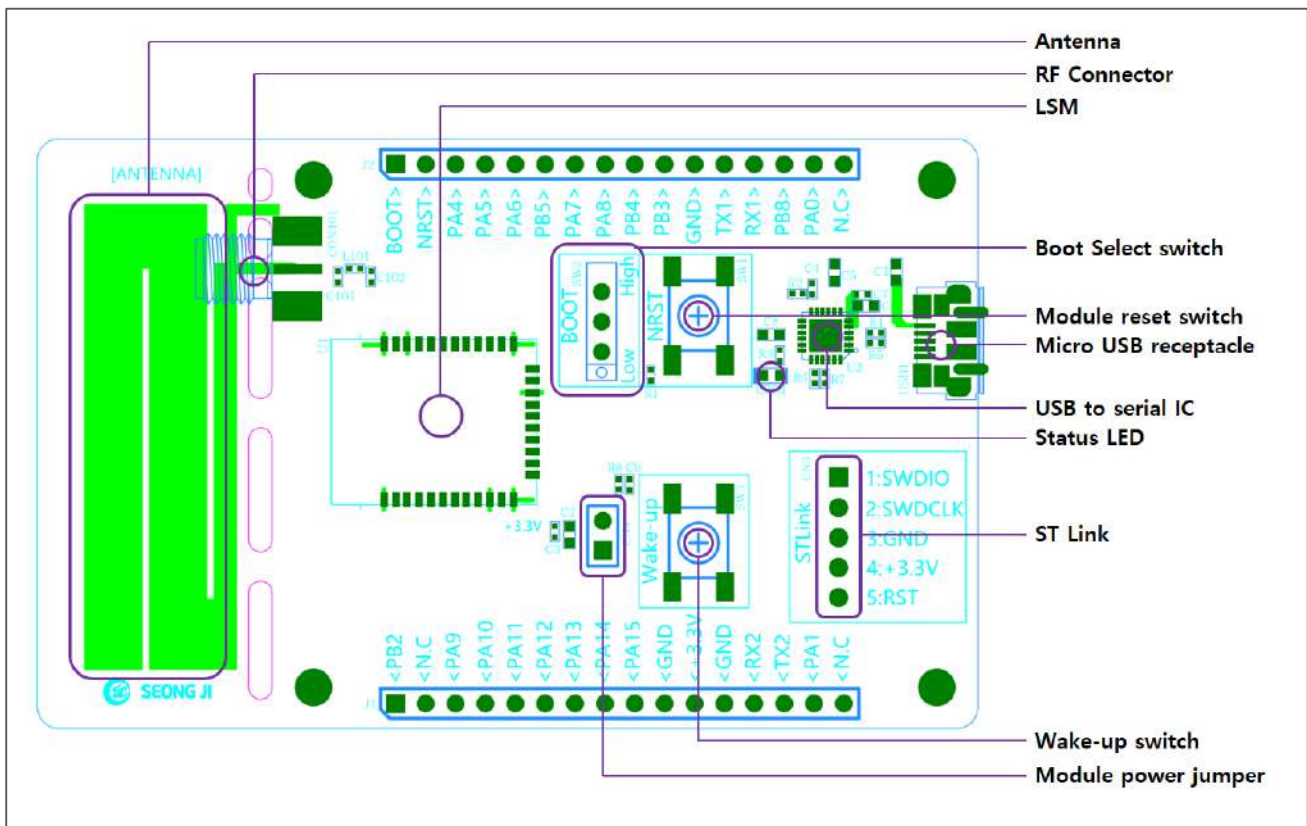

[ Fig. EVM LSM]

- **RF Connector:** RF connector for Antenna
- **LSM:** LoRa - Sigfox module
- **Boot Select switch:** Boot mode Low/High switch (↓ : Low, ↑ : High)
- **Module reset switch:** EVB LSM H/W reset switch
- **Micro USB receptacle:** Micro USB connector
  - ① Power supply
  - ② Virtual UART interface
- **USB to serial IC:** FT2232HL/ FTDI
- **Status LED:** Debug & Module status LED
- **ST Link:** ST Link connector
- **Wake-up switch:** wake-up switch
- **Module power Jumper:** EVB LSM power supply jumper PIN
- **Module external power PIN:** EVB LSM external power supply PIN (+3.3V supply)

### 1.3 Schematic

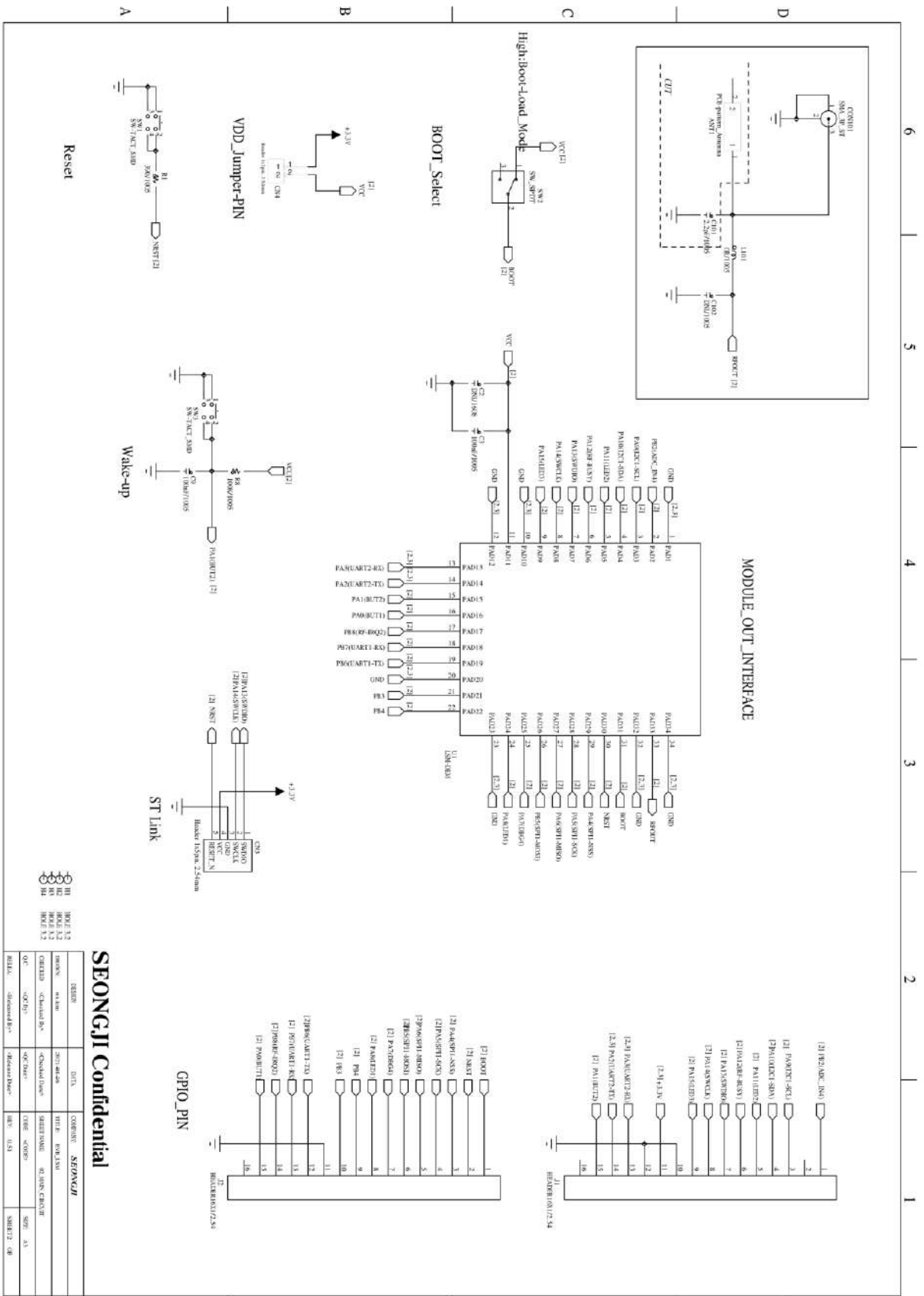

**SEONGJII Confidential**

DESIGN	DATE	COMPILE	SEONGJII
REV01	2017.04.28	TITLE	LSM100A
REV02		DESIGNED BY	SHIN CHANG
REV03		CHECKED BY	SHIN CHANG
REV04		DATE	2017.04.28
REV05		FILE	LSM100A.DWG
REV06		SCALE	1:1
REV07		DATE	2017.04.28
REV08		FILE	LSM100A.DWG
REV09		SCALE	1:1
REV10		DATE	2017.04.28
REV11		FILE	LSM100A.DWG
REV12		SCALE	1:1
REV13		DATE	2017.04.28
REV14		FILE	LSM100A.DWG
REV15		SCALE	1:1
REV16		DATE	2017.04.28
REV17		FILE	LSM100A.DWG
REV18		SCALE	1:1
REV19		DATE	2017.04.28
REV20		FILE	LSM100A.DWG
REV21		SCALE	1:1
REV22		DATE	2017.04.28
REV23		FILE	LSM100A.DWG
REV24		SCALE	1:1
REV25		DATE	2017.04.28
REV26		FILE	LSM100A.DWG
REV27		SCALE	1:1
REV28		DATE	2017.04.28
REV29		FILE	LSM100A.DWG
REV30		SCALE	1:1
REV31		DATE	2017.04.28
REV32		FILE	LSM100A.DWG
REV33		SCALE	1:1
REV34		DATE	2017.04.28
REV35		FILE	LSM100A.DWG
REV36		SCALE	1:1
REV37		DATE	2017.04.28
REV38		FILE	LSM100A.DWG
REV39		SCALE	1:1
REV40		DATE	2017.04.28
REV41		FILE	LSM100A.DWG
REV42		SCALE	1:1
REV43		DATE	2017.04.28
REV44		FILE	LSM100A.DWG
REV45		SCALE	1:1
REV46		DATE	2017.04.28
REV47		FILE	LSM100A.DWG
REV48		SCALE	1:1
REV49		DATE	2017.04.28
REV50		FILE	LSM100A.DWG

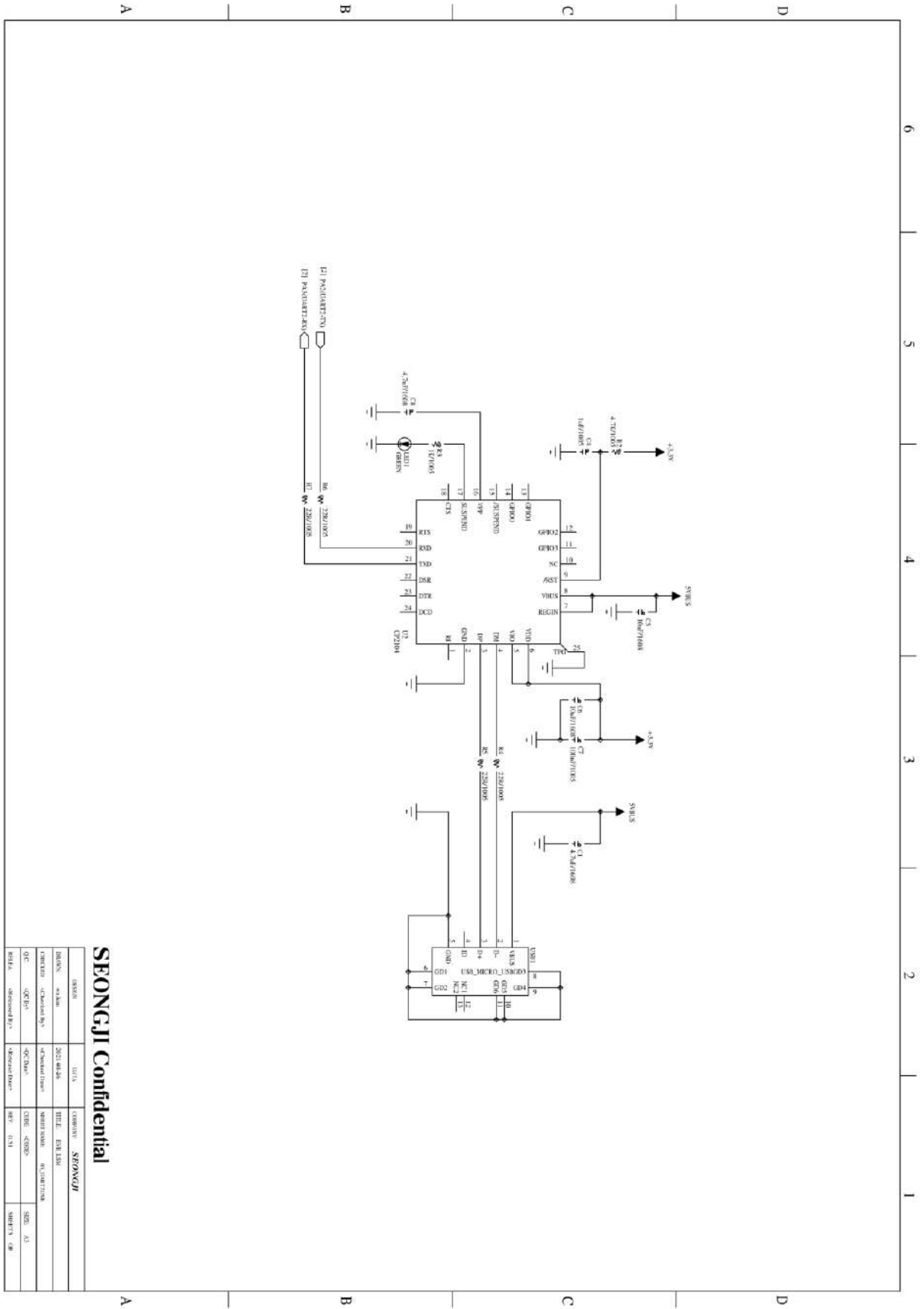

**SEONGJI Confidential**

DESIGN	DATE	COMPANY	SEONGJI
REVISED	NO. 2021.04.28	TITLE	LSM100A
CHECKED	APPROVED BY	SHIPPING	REVISION
QC	QC BY	QC DATE	QC CODE
REPAIR	REPAIR BY	REPAIR DATE	REPAIR CODE

## 1.4 Connector PIN Description

Connector	Pin No.	Pin name	Module Pin No.	Function
J1	1	PB2	2	AC/DC In
	2	-	-	-
	3	PA9	3	Inter-Integrated Circuit Serial Clock (SCL)
	4	PA10	4	Inter-Integrated Circuit Serial Data (SDA)
	5	PA11	5	General purpose IO
	6	PA12	6	General purpose IO
	7	PA13	7	Serial Wire Debug Data (FW Download)
	8	PA14	8	Serial Wire Debug Clock (FW Download)
	9	PA15	9	General purpose IO
	10	GND	-	Ground
	11	VDD	11	Power Supply(+1.8V ~ +3.6V)
	12	GND	12	Ground
	13	PA3	13	UART2 Receive Data
	14	PA2	14	UART2 Transmit Data
	15	PA1	15	Wake-up, General purpose IO
	16	-	-	-

Connector	Pin No.	Pin name	Module Pin No.	Function
J2	1	BOOT	31	IC Boot0
	2	NRST	30	IC Reset
	3	PA4	29	Selectable SPI1 functionality (NSS)
	4	PA5	28	Selectable SPI1 functionality (SCK)
	5	PA6	27	Selectable SPI1 functionality (MISO)
	6	PB5	26	Selectable SPI1 functionality (MOSI)
	7	PA7	25	General purpose IO
	8	PA8	24	General purpose IO
	9	PB4	22	General purpose IO
	10	PB3	21	General purpose IO
	11	GND	20	Ground
	12	PB6	19	UART1 Transmit Data
	13	PB7	18	UART1 Receive Data
	14	PB8	17	General purpose IO
	15	PA0	16	General purpose IO
	16	-	-	-

### 1.5 Antenna Dimension

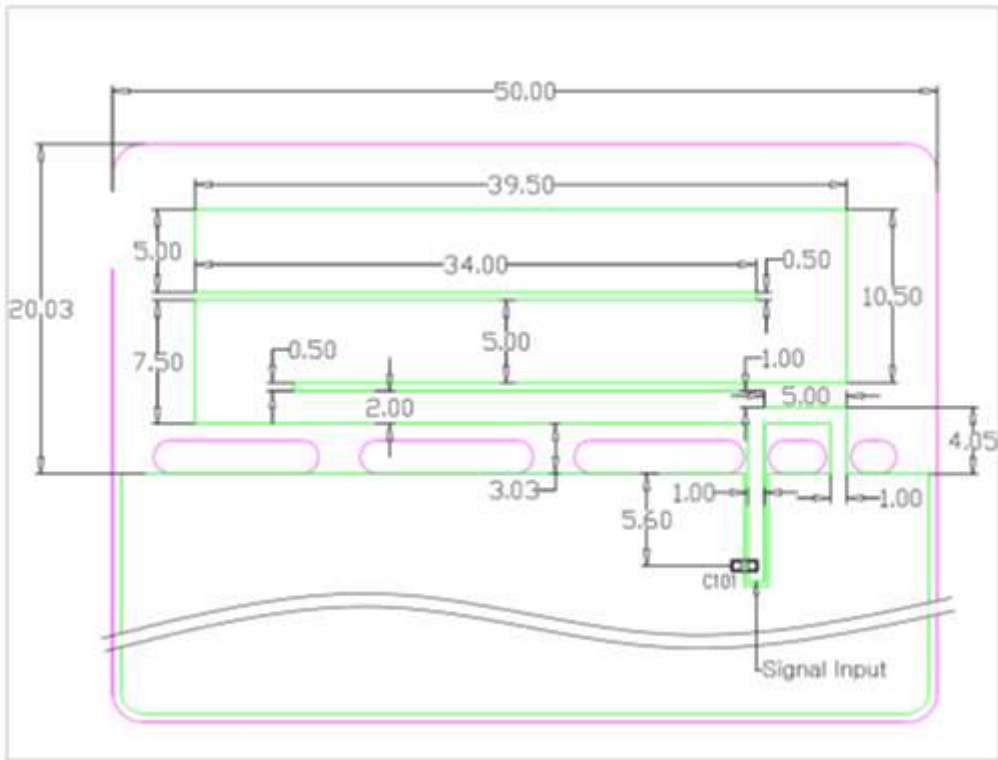

[ Antenna Pattern ]

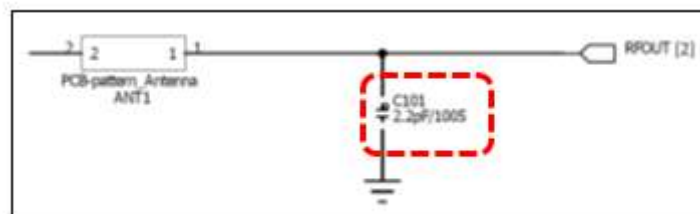

[ Matching ]



## 1.6 Return loss & VSWR

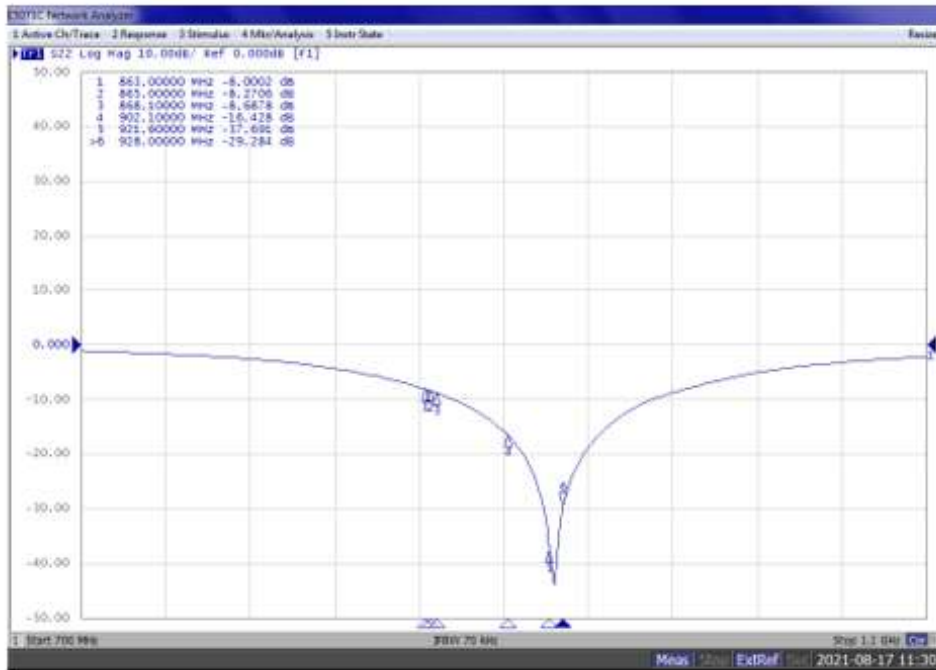

[ Return Loss ]

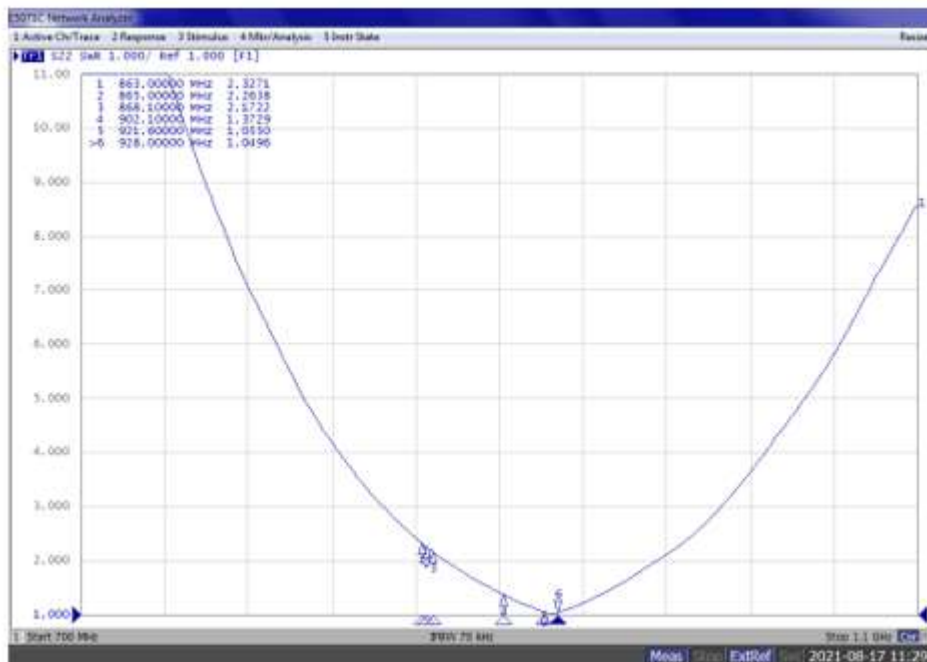

[ VSWR ]

### 1.7 2D Radiation Pattern

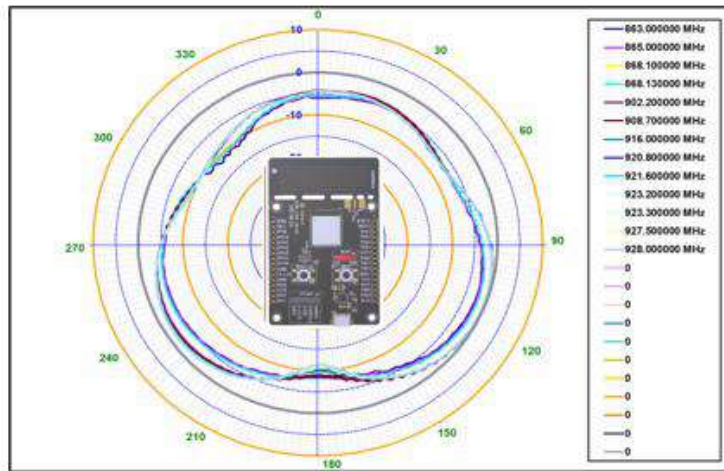

[ X-Y ]

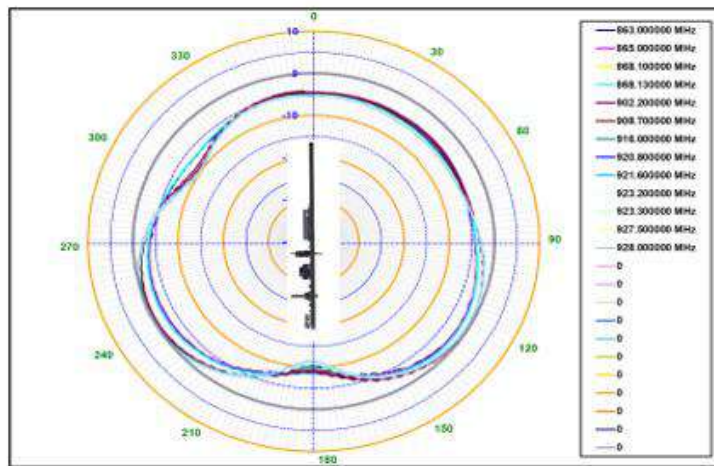

[ Y-Z ]

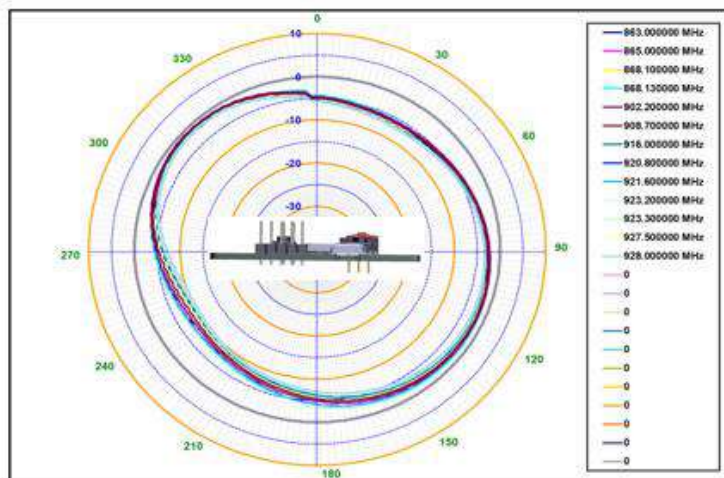

[ X-Z ]



### 1.9 EVB Radiation → Conduction Change

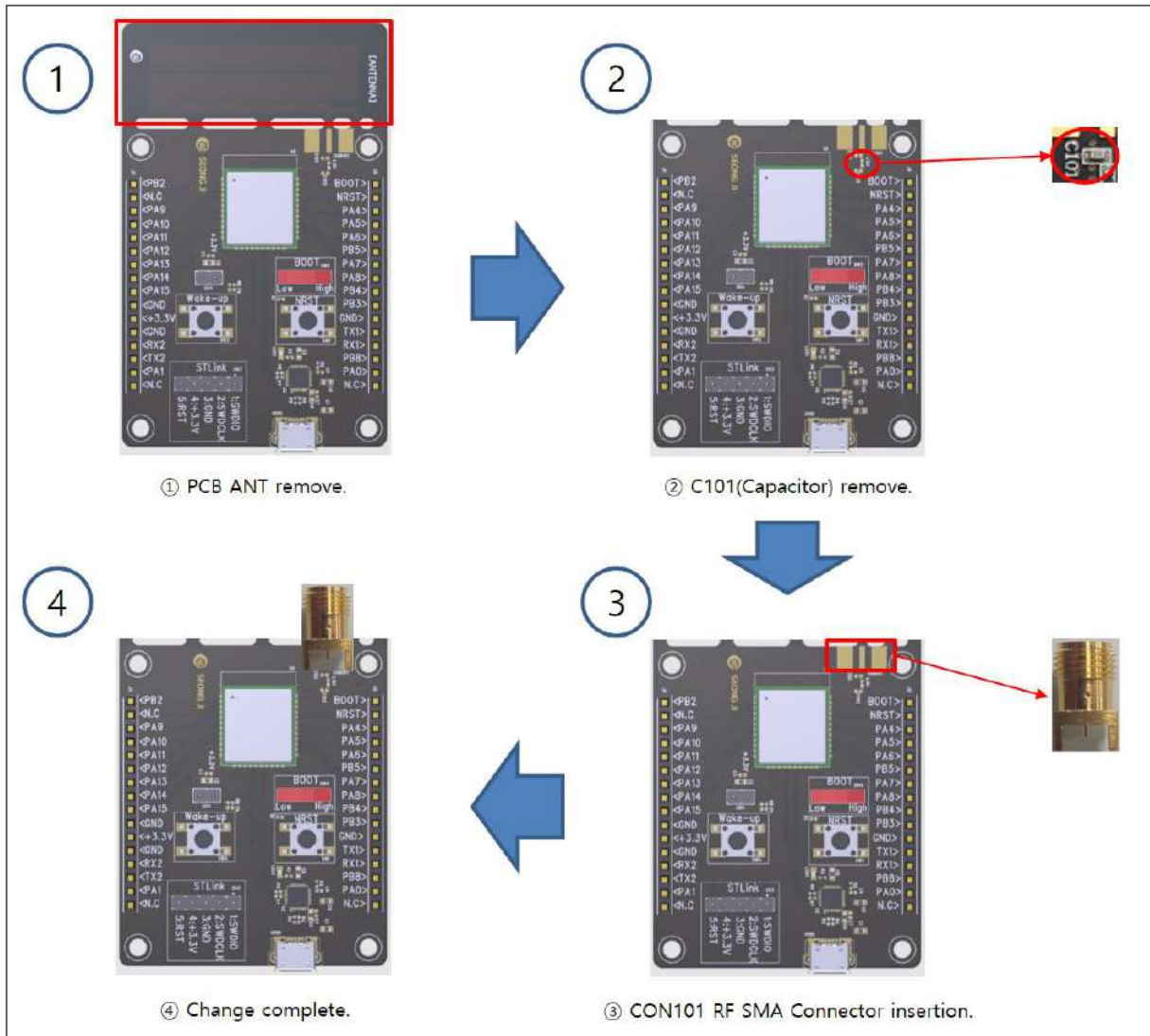

## 2. Memory map

- LSM100A F/W version: V1.0.1
- LSM100A IAP(Bootloader)
  - ◆ Start address: 0x08000000
  - ◆ End address: 0x08001FFF
  - ◆ Size: 0x2000(8,192byte)
  - ◆ Area in IAP
- LSM100A F/W
  - ◆ Start address: 0x08002000
  - ◆ End address: 0x0802FFFF
  - ◆ Size: 0x2E000(188,416byte)
  - ◆ Area in LSM100A F/W
- LoRa user area
  - ◆ Start address: 0x0803A000
  - ◆ End address: 0x0803BFFF
  - ◆ Size: 0x2000(8,192byte)
  - ◆ Area in LoRa user data
- Sigfox user area
  - ◆ Start address: 0x0803C000
  - ◆ End address: 0x0803DFFF
  - ◆ Size: 0x2000(8,192byte)
  - ◆ Area in Sigfox user data
- Sigfox ID/PAC
  - ◆ Start address: 0x0803E000
  - ◆ Area in Sigfox ID, PAC

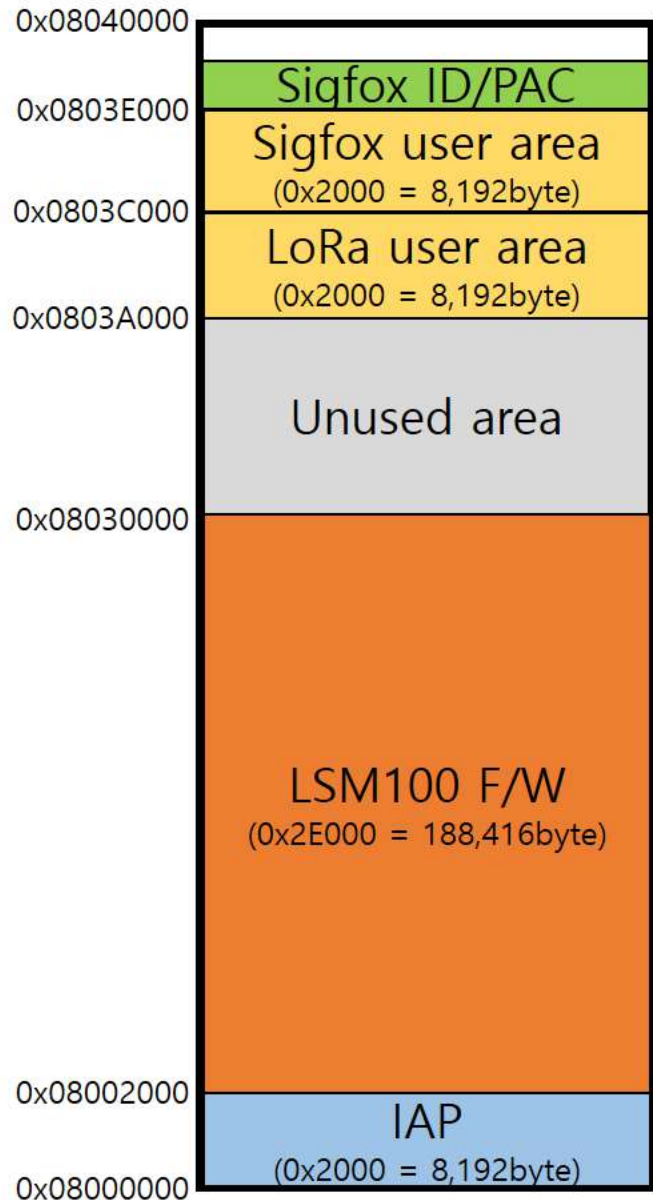

The Sigfox ID/PAC(Credentials) is placed at 0x0803E500. **(The Sigfox area must not be erased and modified.)**

**※ Warning: Never erase the entire memory.**

**Users are responsible for any problems caused by the erase.**



### 3. Test Program

#### 3.1 Evaluation board Connection

- 1) EVBLSM100A connect to Window PC by USB cable.

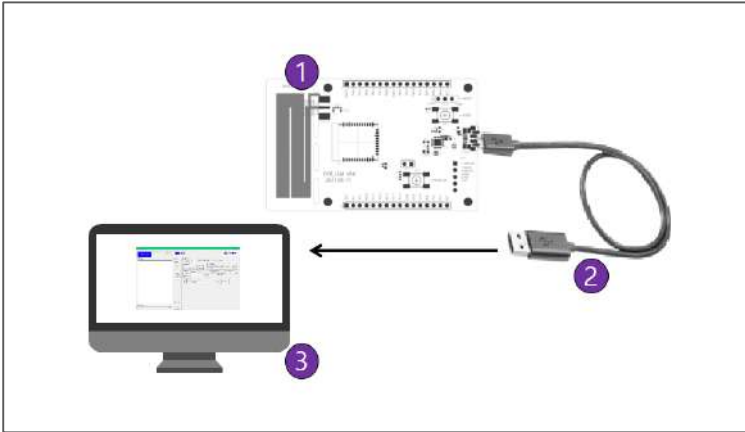

- ① LSM100A
- ② Micro USB cable
- ③ Windows PC

[ Fig. EVBLSM100A connection ]

#### 3.2 Program execution

- 1) EVBLSM100A connected serial-port in Windows PC, and then check the COM-port number in device manager.

➔ USB Serial Port(Com□□)

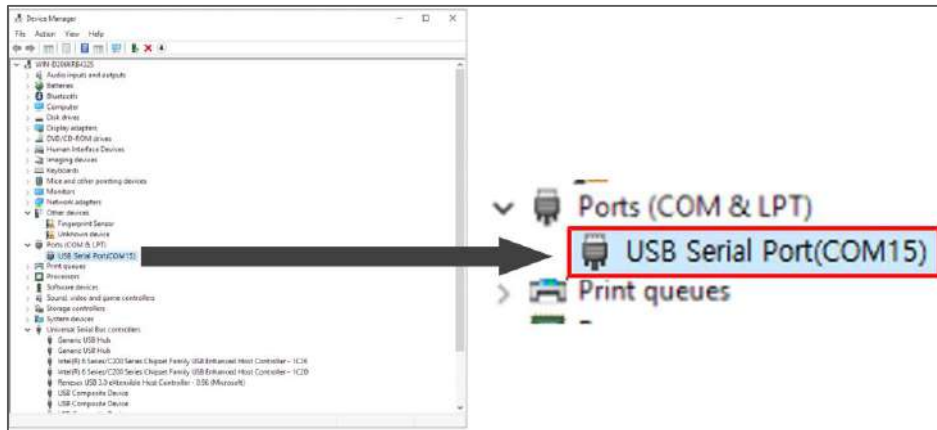

[ Fig. EVBLSM100A serial port ]

- 2) Run serial communication program "LSM\_LoRa(Sigfox)\_CMD\_vXX.exe"
- 3) Write serial port Number in 'DUTCOM' BOX, and then 'connect' click.



Serial port number

[ Fig. EVBLSM100A serial port number ]

### 3.3 Test program Description

#### 3.3.1 Lora command GUI

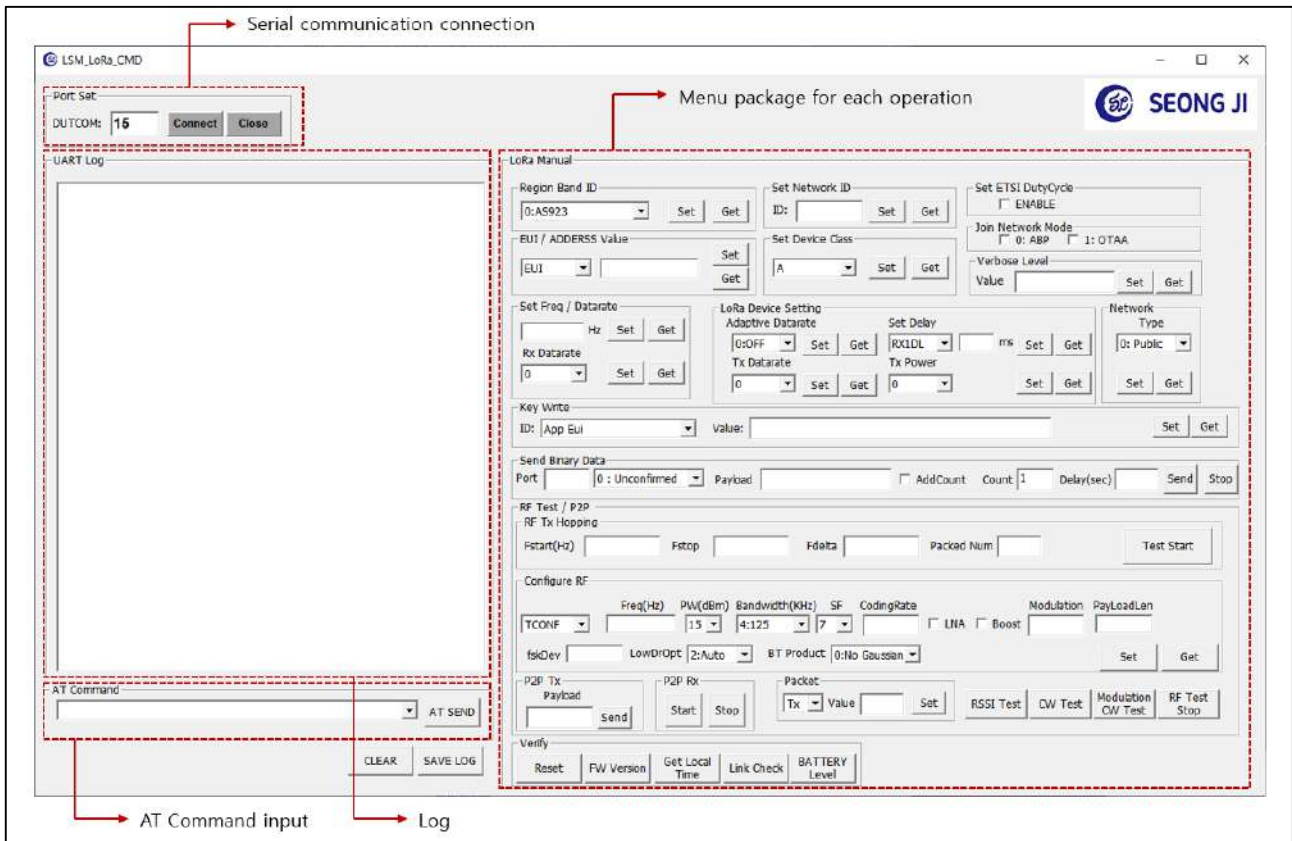

[ Fig. Screen of execute Test program ]

- 1) Write command on AT Command edit box located on left bottom and then click Send button to execute command. Configuration value list is defined on chapter "AT command complete set"
- 2) Instead of the item 1), can click button to execute on each AT command menu package on the right.

Example)

Command : AT+BAND=5 (CR)      AT+BAND=? (CR)

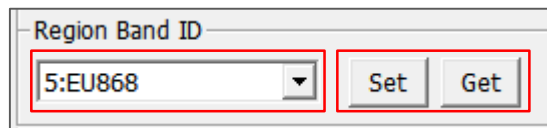

[ Fig. Region Band ID Set Command ]

### 3.3.2 Lora RF Test Description

1) Configure RF test

General Setting

**\* Conf RF Test Setting**(Required to set every device reset)

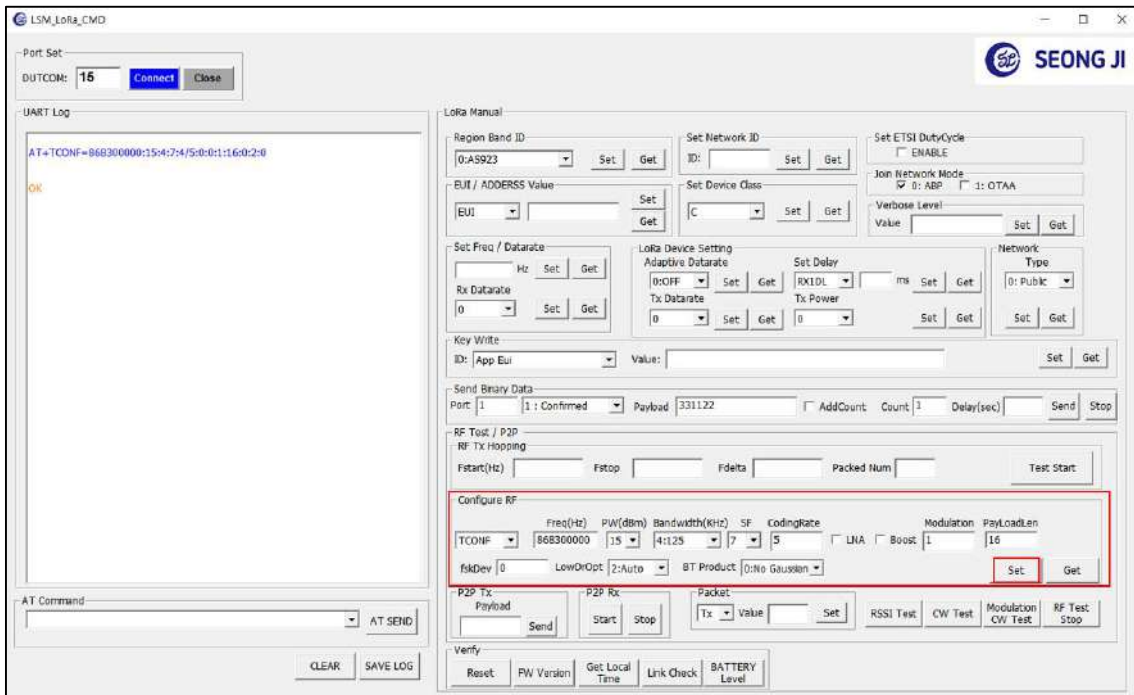

- As in the picture above, enter parameters without spaces and Set

AT+TCNF= <Frequency>:<Power>:<LoRa Bandwidth>:<Lora SF>:<CodingRate>:<Lna>:<PA Boost>:  
<Modulation>:<PayloadLen>:<FskDeviation>:<LowDrOpt >:<BTproduct:> <CR>

EX) AT+TCNF=868300000:15:4:7:4/5:0:0:1:16:0:2:0



2) Tx Test

After selecting Tx in the Packet part, set the number of times to repeat Value and Send.

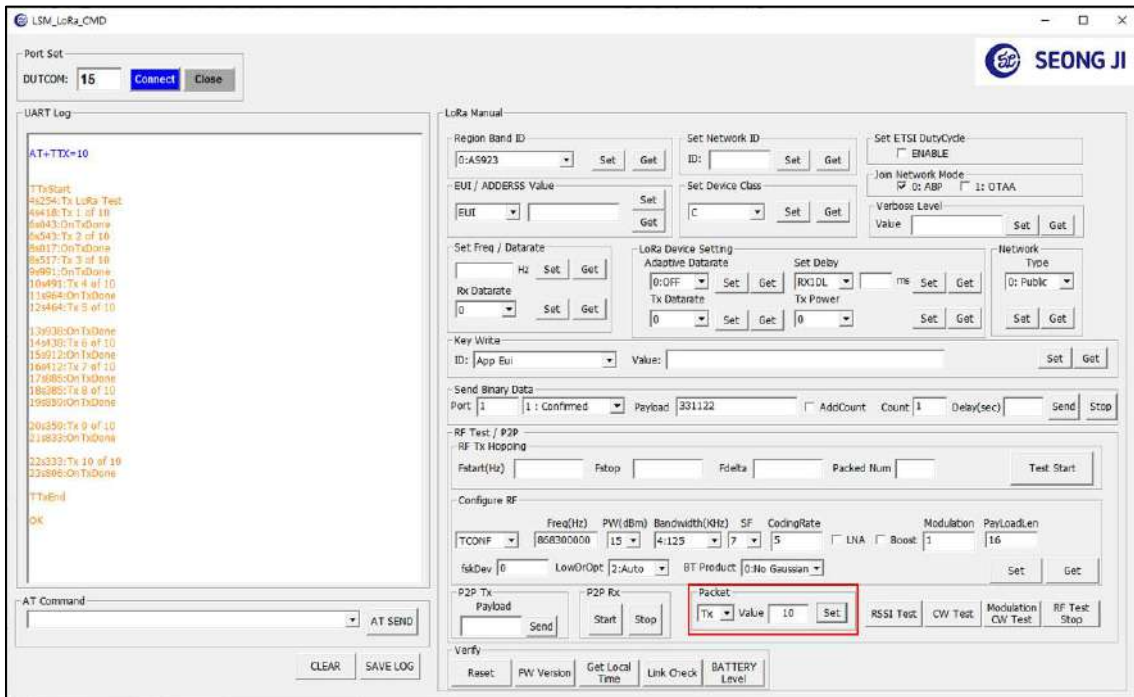

3) Rx Test

After selecting Rx in the Packet part, set the number of times to repeat Value and Send.

- ➔ if received success display "OnRxDone"
- ➔ if received fail display "OnRxTimeout"

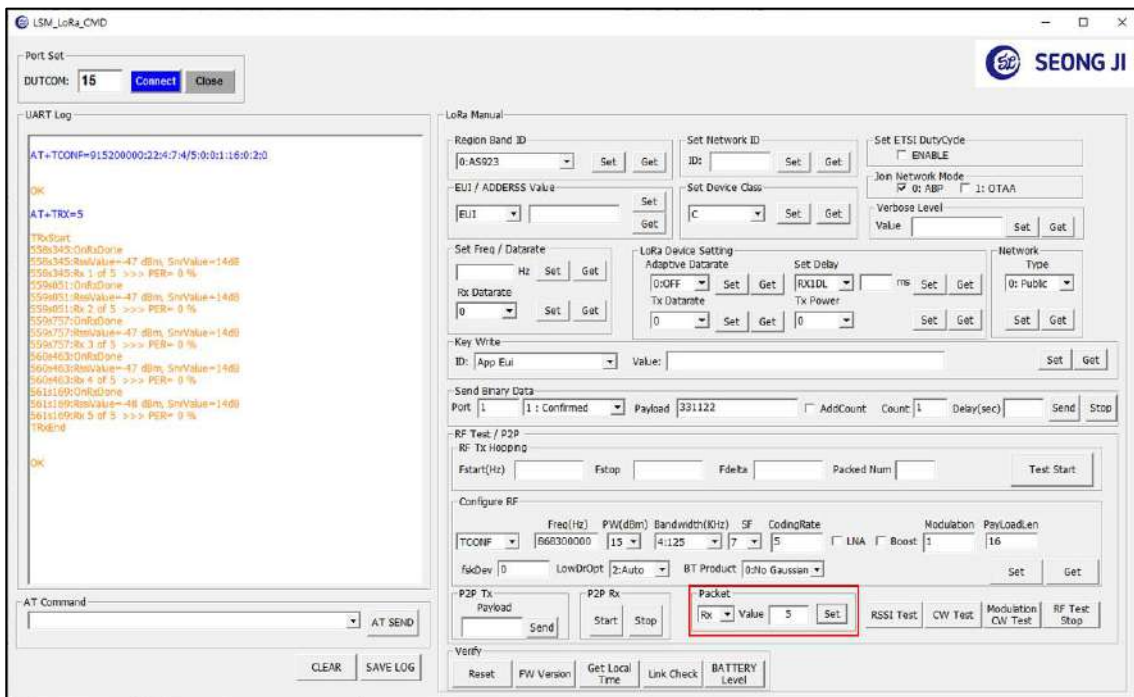

### 3.3.3 Sigfox command GUI

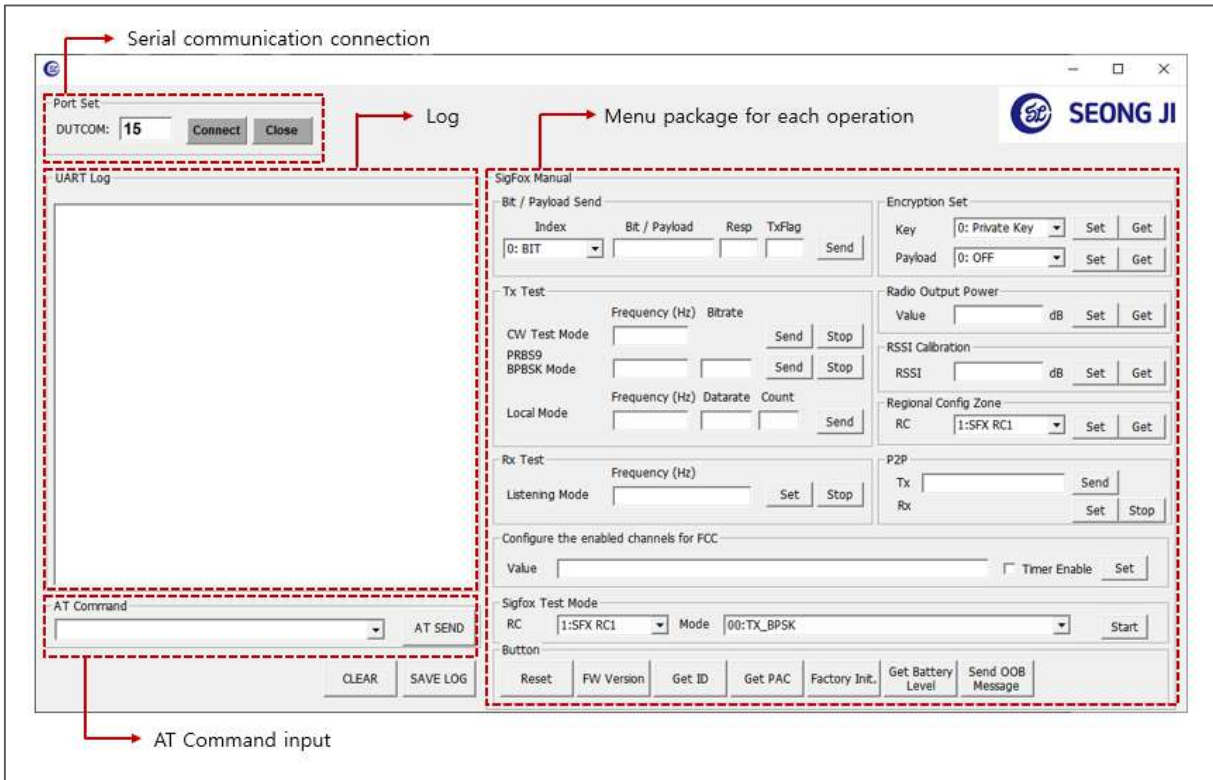

[ Fig. Screen of execute Test program ]

◎ **The LSM100A supports only RC1 and doesn't support monarch**

- 1) Write command on AT Command edit box located on left bottom and then click Send button to execute command. Configuration value list is defined on chapter "AT command complete set"
- 2) Instead of the item 2), can click button to execute on each AT command menu package on the right.

Example)

Command: `ATS410=0 (CR)` (0: private key 1: public key)

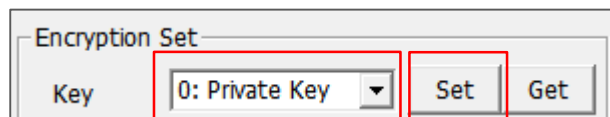

[ Fig. Encryption Set Command ]

### 3.3.4 Sigfox RF Test Description

- 1) Input AT Command to LSM100A used as RX  
 EX) AT+RL=869525000
  
- 2) Test Result
  - ➔ if received success display "TEST PASSED"
  - ➔ if received fail display "Wait For End of Rx"

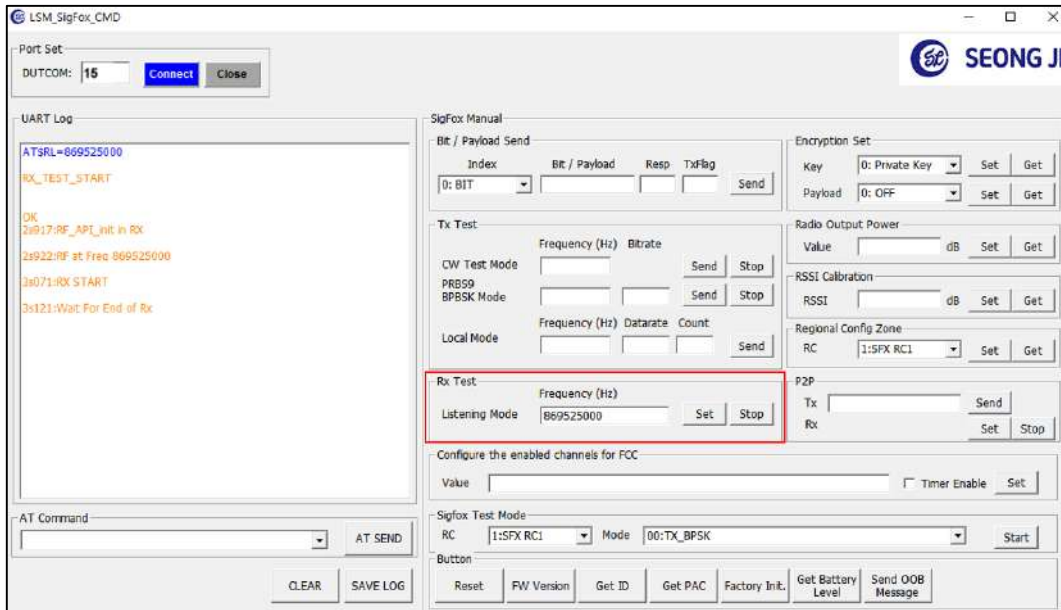

- 3) Input AT Command to LSM100A used as TX  
 EX) AT+CW=868130000  
 ➔ Transmit frequency to Continuous wave

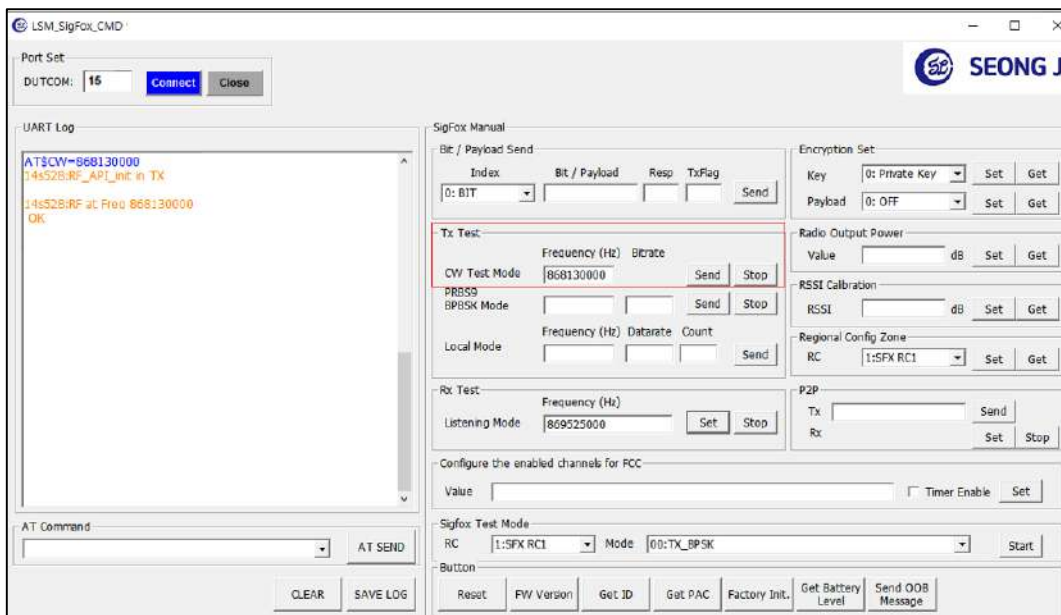

## 4. AT command complete set

A typical serial terminal emulator can also be used to control the EVK instead of the proposed test SW. In that case, the following parameters should be used:

- Speed : 9600 bauds
- Data bits: 8
- Stop bits: 1
- Parity: None
- Port: UART2 (EVK's micro 5pin connector is connected to UART2..)

The following table gather all AT command available:

### 4.1 LoRa Command

Command	Name	Description
AT?	Help on all <CMD>	Help on All Commands.  Ex) AT? (CR)
ATZ	Reset	Trig a MCU reset.  Ex) ATZ (CR)
AT+BAT=?	Battery level	Get the battery level (in mV).  Ex) AT+BAT=? (CR)
AT+VL=level AT+VL=?	Verbose level	Set or Get the verbose level. <level>: [ 0: off ~ 3: High ]  Ex) AT+VL=3 (CR)
AT+MODE=mode AT+MODE=?	Mode Change	LoRa & Sigfox Mode Change. After a MCU reset. <mode>: [ 0: Sigfox, 1: LoRa ]  Ex) AT+MODE=1 (CR)
AT\$SSWVER=?	Software version	Get the Software version.  Ex) AT\$SSWVER=? (CR)
AT+VER=?	Firmware and library versions	Get the version of firmware and libraries.  Ex) AT+VER=? (CR)
AT+LTIME=?	Local time in UTC format	Get the local time in UTC format.

		Ex) AT+LTIME=? (CR)
AT+LINKC?	Link Check	Piggyback a Link Check Request to the next uplink.  Ex) AT+LINKC? (CR)
AT+APPEUI=eui AT+APPEUI=?	Application EUI	Set or Get the Application EUI.  Ex) AT+APPEUI=00:00:00:00:00:00:07 (CR)
AT+NWKKEY=key AT+NWKKEY=?	Network Key	Set or Get the Network Key.  Ex) AT+NWKKEY=00:11:22:33:44:55:66:77:88:99:AA:BB:CC:DD:EE:FF (CR)
AT+APPKEY=key AT+APPKEY=?	Application Key	Set or Get the Application Key.  Ex) AT+APPKEY=00:11:22:33:44:55:66:77:88:99:AA:BB:CC:DD:EE:FF (CR)
AT+NWKSKEY=key AT+NWKSKEY=?	Network Session Key	Set or Get the Network Session Key.  Ex) AT+NWKSKEY=00:11:22:33:44:55:66:77:88:99:AA:BB:CC:DD:EE:FF (CR)
AT+APPSKEY=key AT+APPSKEY=?	Application Session Key	Set or Get the Application Session Key.  Ex) AT+APPSKEY=00:11:22:33:44:55:66:77:88:99:AA:BB:CC:DD:EE:FF (CR)
AT+DADDR=address AT+DADDR=?	Device address	Set or Get the Device address.  Ex) AT+DADDR=00:11:22:33 (CR)
AT+DEUI=?	Device EUI	Get the Device EUI.  Ex) AT+DEUI=? (CR)
AT+NWKID=id AT+NWKID=?	Network ID	Set or Get the Network ID. <id>: [ 0 ~ 127 ].  Ex) AT+NWKID=100 (CR)
AT+JOIN=mode AT+JOIN=?	Join network with Mode	Join network with Mode. <mode> [ 0: ABP, 1: OTAA ]  Ex) AT+JOIN=1 (CR)

<p>AT+SEND=port:ack:data</p>	<p>Send binary data</p>	<p>Send binary data with the application                  &lt;Port&gt; [ 1 ~ 199 ]                  &lt;Ack&gt; [ 0: unconfirmed, 1: confirmed ]</p> <p>Ex) AT+SEND=1:1:123456789012345678901234567890                  123456789012345678901234567890123456 (CR)</p>
<p>AT+ADR=mode AT+ADR=?</p>	<p>Adaptive DataRate</p>	<p>Set or Get the Adaptive DataRate setting.                  &lt;mode&gt;: [ 0: Off, 1: On ]</p> <p>Ex) AT+ADR=0 (CR)</p>
<p>AT+DR=datarate AT+DR=?</p>	<p>Tx DataRate</p>	<p>Set or Get the Tx DataRate.                  Activation when ADR off Only                  &lt;datarate&gt;: [ 0 ~ 7 ]</p> <p>[ AU915 : 2 ~ 7 / US915 : 0 ~ 4 ]                  0: LoRa - SF12 / 125 kHz, bit rate - 250 bit/s                  1: LoRa - SF11 / 125 kHz, bit rate - 440 bit/s                  2: LoRa - SF10 / 125 kHz, bit rate - 980 bit/s                  3: LoRa - SF9 / 125 kHz, bit rate - 1760 bit/s                  4: LoRa - SF8 / 125 kHz, bit rate - 3125 bit/s                  5: LoRa - SF7 / 125 kHz, bit rate - 5470 bit/s                  6: LoRa - SF7 / 250 kHz, bit rate - 11000 bit/s                  7: FSK - 50 kbps, bit rate - 5000 bit/s</p> <p>Ex) AT+DR=0 (CR)</p>
<p>AT+TXP=power AT+TXP=?</p>	<p>Transmit Power</p>	<p>Set or Get the Transmit Power.                  (valid range according to region)                  &lt;power&gt;: [ 0 ~ 15 ]</p> <p>AS923: [ 0~7 ] AU915: [ 0~14 ] CN779: [ 0~5 ]                  EU868: [ 0~7 ] KR920: [ 0~7 ] IN865: [ 0~10 ]                  US915: [ 0~14 ] RU864: [ 0~7 ]</p> <p>Ex) AT+TXP=0 (CR) ( in KR920 0: MAX ERP )</p>
<p>AT+BAND=band AT+BAND=?</p>	<p>Active Region Band ID</p>	<p>Set or Get the Active Region Band ID. [ 0 ~ 9 ]                  &lt;band&gt;: [0,1: AS923-1, 0,4: AS923-1_JP, 1: AU915,                  2: CN470, 3: CN779, 4: EU433, 5: EU868, 6: KR920, 7: IN865,                  8: US915, 9: RU864]</p> <p>Ex) AT+BAND=0 (CR)</p>

AT+CLASS=class AT+CLASS=?	Device Class	Set or Get the Device Class. <Class>: [A, B, C]  Ex) AT+CLASS=? (CR)
AT+DCS=mode AT+DCS=?	ETSI DutyCycle	Set or Get the ETSI DutyCycle. <mode>: [ 0: disable, 1: enable ] - Only for testing  Ex) AT+DCS=0 (CR) ( for KR920, AS923, AU915,.. )
AT+RX2FQ=freq AT+RX2FQ=?	Rx2 window Freq	Set or Get the Rx2 window. <freq>: Frequency (in Hz)  Ex) AT+RX2FQ=869525000 (CR)
AT+RX2DR=datarate AT+RX2DR=?	Rx2 window DataRate	Set or Get the Rx2 window DataRate. <datarate>: [ 0 ~ 13 ] AS923: [ 0~7 ] AU915: [ 2~13 ] CN779: [ 0~7 ] EU868: [ 0~7 ] KR920: [ 0~5 ] IN865: [ 0~5 ] US915: [ 8~13 ] RU864: [ 0~7 ]  Ex) AT+RX2DR=0 (CR)
AT+RX1DL=delay AT+RX1DL=?	Delay between end of Tx and Rx Window 1	Set or Get the delay between the end of the Tx and the Rx Window 1. <delay>: delay (in ms)  Ex) AT+RX1DL=1000 (CR)
AT+RX2DL=delay AT+RX2DL=?	Delay between end of Tx and Rx Window 2	Set or Get the delay between the end of the Tx and the Rx Window 2 in ms. <delay>: delay (in ms)  Ex) AT+RX2DL=2000 (CR)
AT+JN1DL=delay AT+JN1DL=?	Join Accept Delay between end of Tx and Join Rx Window 1	Set or Get the Join Accept Delay between the end of the Tx and the Join Rx Window 1 in ms. <delay>: delay (in ms)  Ex) AT+JN1DL=5000 (CR)

<p>AT+JN2DL=delay AT+JN2DL=?</p>	<p>Join Accept Delay between end of Tx and Join Rx Window 2</p>	<p>Set or Get the Join Accept Delay between the end of the Tx and the Join Rx Window 2 in ms. &lt;delay&gt;: delay (in ms)  Ex) AT+JN2DL=6000 (CR)</p>
<p>AT+NWKTYPE=type AT+NWKTYPE=?</p>	<p>Network Type</p>	<p>Set or Get the Network Type setting Type &lt;type&gt;: [ 0: Public, 1: Private ]  Ex) AT+NWKTYPE=1 (CR)</p>
<p>AT+PGSLOT=period</p>	<p>Ping Slot</p>	<p>Set or Get the unicast ping slot Period &lt;period&gt;: [ 0:1s ~ 7:128s ] (=2^Period)  Ex) AT+PGSLOT=3 (CR)</p>
<p>AT+TTH=fstart:fstop:fdelta a:packetnb</p>	<p>Test Tx Hopping</p>	<p>Starts RF Tx hopping test from Fstart to Fstop in Hz or MHz, Fdelta in Hz. Class B test. &lt;fstart&gt;: frequency (in Hz or MHz) &lt;fstop&gt;: frequency (in Hz or MHz) &lt;fdelta&gt;: frequency (in Hz)  Ex) AT+TTH=867:869:500000:10 (CR)</p>
<p>AT+TCONF=frequency:power:bandwidth:sf:codingrate:lina:paboost:modulation:payloadlen:fskdeviation:lowdropt:btproduct</p>	<p>Configure RF</p>	<p>Configure RF test.  &lt;Frequency&gt;: [ ex: 868300000 ]Hz &lt;Power&gt;: [ -9 ~ 22 ]dBm Max 15dBm at Low Power &lt;Bandwidth&gt;: Lora [ 4: 125, 5: 250, 6: 500 ]kHz, or FSK: [ 4800Hz : 467000 ]Hz &lt;SF&gt;: [ 7 ~ 12 ] or &lt;FSK&gt;: [ 600 ~ 300000 ] &lt;CodingRate&gt;: [ 4/5, 4/6, 4/7, 4/8 ] &lt;Lna&gt;: [ 0: Off, 1: On ] &lt;PA Boost&gt;: [ 0: Off, 1: On ] &lt;Modulation&gt;: [ 0: FSK, 1: LoRa, 2: BPSK ] &lt;PayloadLen&gt;: [ 1 ~ 256 ] &lt;FskDev&gt;: FSK Only [ 600 ~ 20000 ] &lt;LowDrOpt&gt;: Lora Only [ 0: off, 1: On, 2: Auto ] &lt;BTproduct&gt;: [ 0: no Gaussian Filter Applied, 1: BT=0,3, 2: BT=0,5, 3: BT=0,7, 4: BT=1 ]  Ex) AT+TCONF=868300000:15:4:7:4/5:0:0:1:16:0:2:0 (CR)</p>



AT+TTONE	RF Tx Tone test	Starts RF Tx Tone test ( <b>CW Test Mode</b> )  Ex) AT+TTONE (CR)
AT+TRSSI	RF Rx RSSI test	Starts RF Rx RSSI test.  Ex) AT+TRSSI (CR)
AT+TTX=packetnb	Test RF Tx	Starts RF Tx test: Nb of packets sent.  Ex) AT+TTX=16 (CR)
AT+TRX=packetnb	Test RF Rx	Starts RF Rx test: Nb of packets expected. <b>Stop by input 'X'</b>  Ex) AT+TRX=16 (CR)
AT+MTX	Test RF Modulation wave	Starts RF Tx test: Modulation Continuous Wave  Ex) AT+MTX (CR)
AT+MRX	Test RF Continuous Rx	Starts RF Rx test: Continuous receive <b>Stop by input 'X'</b>  Ex) AT+MRX (CR)
AT+TOFF	Stop RF test	Stops on-going RF test.  Ex) AT+TOFF (CR)

AT+PCONF=frequency;power:bandwidth:sf:codingrate:lina:paboost:modulation:payloadlen:fskdeviation:lowdropt:btproduct	P2P Configure	<p>Set or Get configure P2P.</p> <p>&lt;Frequency&gt;: [ ex: 868300000 ]Hz          &lt;Power&gt;: [ -9 ~ 22 ]dBm    Max 15dBm at Low Power          &lt;Bandwidth&gt;: Lora [ 4: 125, 5: 250, 6: 500 ]kHz,                            or FSK: [ 4800Hz : 467000 ]Hz          &lt;SF&gt;: [ 7 ~ 12 ] or &lt;FSK&gt;: [ 600 ~ 300000 ]          &lt;CodingRate&gt;: [ 4/5, 4/6, 4/7, 4/8 ]          &lt;Lna&gt;: [ 0: Off, 1: On ]          &lt;PA Boost&gt;: [ 0: Off, 1: On ]          &lt;Modulation&gt;: [ 0: FSK, 1: LoRa, 2: BPSK ]          &lt;PayloadLen&gt;: [ 1 ~ 256 ]          &lt;FskDev&gt;: FSK Only [ 600 ~ 20000 ]          &lt;LowDrOpt&gt;: Lora Only [ 0: off, 1: On, 2: Auto ]          &lt;BTproduct&gt;: [ 0: no Gaussian Filter Applied, 1: BT=0,3, 2: BT=0,5, 3: BT=0,7, 4: BT=1 ]</p> <p>Ex) AT+PCONF=868300000:15:4:7:4/5:0:0:1:16:0:2:0 (CR)</p>
AT+PSEND=data	P2P Data Send	<p>Send binary data with P2P.</p> <p>Ex) AT+PSEND=00112233445566778899AABBCCDDEE (CR)</p>
AT+PRECV	P2P Data Receive	<p>Starts P2P data receive.</p> <p>Stop by input 'X'</p> <p>Ex) AT+PRECV (CR)</p>

## 4.2 Sigfox Command

Command	Name	Description
AT?	Help on all <CMD>	Help on All Commands  Ex) AT? (CR)
ATZ	Reset	Trig a MCU reset.  Ex) ATZ (CR)
ATE=mode	Echo mode	Not used except to set echo mode. <mode>: [ 0: echo ON, 1: echo OFF ]  Ex) ATE=1 (CR) ATE=? (CR)            Get echo mode
AT+BAT=?	Battery level	Get the battery level (in mV).  Ex) AT+BAT=? (CR)
AT+VL=level AT+VL=?	Verbose level	Set or Get the verbose level. <level>: [ 0: off, 1: Low, 2: Meddle, 3: High ]  Ex) AT+VL=3 (CR) AT+VL=? (CR)            Get level
AT+MODE=mode AT+MODE=?	Mode Change	LoRa & Sigfox Mode Change. After a MCU reset. <mode>: [ 0: Sigfox, 1: LoRa ]  Ex) AT+MODE=1 (CR) AT+MODE=? (CR)    Get mode
AT\$SSWVER=?	Software version	Get the Software version.  Ex) AT\$SSWVER=? (CR)
AT+VER=?	Firmware and library versions	Get the version of firmware and libraries.  Ex) AT+VER=? (CR)
AT\$RFS	Factory settings	Restores the factory setting.  Ex) AT\$RFS (CR)
AT\$ID	Device ID	Get the 32-bit device ID.  Ex) AT\$ID (CR)

<p>AT\$PAC</p>	<p>Device PAC</p>	<p>Get the 8-byte device PAC.</p> <p>Ex) AT\$PAC (CR)</p>
<p>AT\$SB=bit_value{,opt_responsewaited}{,opt_txflag}</p>	<p>Bit status</p>	<p>Send a bit to the Sigfox network.</p> <p>&lt;bit_value&gt;: [ 0 or 1 ]</p> <p>&lt;opt_responsewaited&gt; 0: no response waited (default)</p> <p>&lt;opt_responsewaited&gt; 1: response waited</p> <p>&lt;opt_txflag&gt; 0: one Tx frame sent</p> <p>&lt;opt_txflag&gt; 1: three Tx frame sent (default)</p> <p>Ex) AT\$SB=0,1,1 (CR)</p> <p>AT\$SB=1 (CR) sends bit 1 with no response waited.</p> <p>AT\$SB=0,1 (CR) sends bit 0 with a response waited.</p> <p>AT\$SB=0,1,1 (CR) sends bit 0 with a response waited and with three Tx frames sent.</p>
<p>AT\$SF=payload{,opt_responsewaited}{,opt_txflag}</p>	<p>ASCII payload in bytes</p>	<p>Send a frame to the Sigfox network.</p> <p>&lt;payload&gt;: [ 12 bytes maximum in ASCII format (24 ASCII characters max) ]</p> <p>&lt;opt_responsewaited&gt;: [ 0: no response waited (default) ]</p> <p>&lt;opt_responsewaited&gt;: [ 1: response waited ]</p> <p>&lt;opt_txflag&gt;: [ 0: one Tx frame sent ]</p> <p>&lt;opt_txflag&gt;: [ 1: three Tx frames sent (default) ]</p> <p>Ex) AT\$SF=313245,1,1 (CR)</p> <p>AT\$SF=313245 (CR) sends 0x31 0x32 0x45 payload with no response waited.</p> <p>AT\$SF=313245,1 (CR) sends 0x31 0x32 0x45 payload with a response waited.</p> <p>AT\$SF=313245,1,1 (CR) sends 0x31 0x32 0x45 payload with a response waited and with three Tx frames sent.</p>

<p>AT\$SH=payload_length, payload{,opt_responsewait ed}{,opt_txflag}</p>	<p>Hexadecimal payload in bytes</p>	<p>Send a Hex frame to the Sigfox network.                      &lt;payload_length&gt;: [ length in bytes ]                      &lt;payload&gt;: [ 12 bytes maximum in hexadecimal                      format ]                      &lt;opt_responsewait&gt;: [ 0: no response waited                      (default) ]                      &lt;opt_responsewait&gt;: [ 1: response waited ]                      &lt;opt_txflag&gt;: [ 0: one Tx frame sent ]                      &lt;opt_txflag&gt;: [ 1: three Tx frames sent (default) ]</p> <p>Ex) AT\$SH=1,A,1 (CR)                      AT\$SH=1,A (CR) sends 0x41 payload with no                      response waited.                      AT\$SH=1,A,1 (CR) sends 0x41 payload with a                      response waited.</p>
<p>AT\$CW=freq</p>	<p>Continuous wave(CW)</p>	<p>Start or stop a continuous unmodulated carrier for test. Run CW Test mode.                      &lt;freq&gt;: frequency (in Hz)</p> <p>Ex) AT\$CW=868130000 (CR)                      AT\$CW=0 (CR) Stop a CW</p>
<p>AT\$PN=freq,bitrate</p>	<p>PRBS9 BPBSK test mode</p>	<p>Run PRBS9 BPBSK Test mode. Send a continuous modulated carrier for test.                      &lt;freq&gt;: frequency (in Hz)                      &lt;bitrate&gt;: 100 or 600</p> <p>Ex) AT\$PN=868130000,100 (CR)                      AT\$PN=0 (CR) Stop a BPBSK</p>
<p>AT\$RC=rc</p>	<p>Sigfox test mode</p>	<p>Start a Sigfox test mode for setting RC.</p> <p>&lt;rc&gt;                      RC1 = 1      RC3A = 3A      RC3C = 3C</p> <p>Ex) AT\$RC=3C</p>

AT\$TM=rc,mode	Sigfox test mode	<p>Start a Sigfox test mode.</p> <pre>&lt;rc&gt; SFX_RC1 = 1      SFX_RC2 = 2      SFX_RC3C = 3C SFX_RC4 = 4      SFX_RC5 = 5      SFX_RC6 = 6 SFX_RC7 = 7  &lt;mode&gt; SFX_TEST_MODE_TX_BPSK                = 0 SFX_TEST_MODE_TX_PROTOCOL             = 1 SFX_TEST_MODE_RX_PROTOCOL             = 2 SFX_TEST_MODE_RX_GFSK                 = 3 SFX_TEST_MODE_RX_SENSI                = 4 SFX_TEST_MODE_TX_SYNTH                = 5 SFX_TEST_MODE_TX_FREQ_DISTRIBUTION    = 6 SFX_TEST_MODE_TX_BIT                  = 11 SFX_TEST_MODE_PUBLIC_KEY              = 12 SFX_TEST_MODE_NVM                     = 13</pre> <p>Ex) AT\$TM=2,0 (CR)</p>
AT\$RSSICAL=value AT\$RSSICAL=?	RSSI value in dB	<p>Set or Get the RSSI calibration value in dB.</p> <p>&lt;value&gt;: calibration value (in dB)</p> <p>Ex) AT\$RSSICAL=0 (CR) AT\$RSSICAL=? (CR)</p>
AT\$RL=freq	Listening for a data packet	<p>Starts listening for a local loop.</p> <p>&lt;freq&gt;: frequency (in Hz)</p> <p>Stop by input 'X'</p> <p>Ex) AT\$RL=869525000 (CR)</p>
AT\$SL=freq,datarate,count	Send local loop	<p>Send TX packet up to count number for local test.</p> <p>&lt;freq&gt;: frequency (in Hz)</p> <p>&lt;datarate&gt;: data rate (in bps)</p> <p>&lt;count&gt;: send packets counter</p> <p>Ex) AT\$SL=869525000,600,10 (CR)</p>

AT\$RP2P	P2P RX	Starts listening for the P2P. <b>Stop by input 'X'</b>  Ex) AT\$RP2P (CR)
AT\$SP2P=payload	P2P TX	Send TX packet for the P2P. <payload>: [ 12 bytes maximum in ASCII format (24 ASCII characters max) ]  Ex) AT\$SP2P=112233445566778899AABBCC (CR)
ATS300	Out-of-band message	Send one keep-alive out-of-band message.  Ex) ATS300 (CR)
ATS302=power ATS302=?	Radio output power	Set or Get the radio output power. <power> : power (in dBm)  Ex) ATS302=15 (CR) ATS302=? (CR) Get power
ATS400=<8_digit_word0> <8_digit_word1><8_digit_word2>,timer_enable	Enabled channels for FCC	Configure the enabled channels for FCC.  Ex) ATS400=000000004000000000000000,0 (CR)
ATS410=key ATS410=?	Encryption key	Set or Get the configuration of the device encryption key. <key>: [ 0: Use Private key, 1: Use Public key ]  Ex) ATS410=1 (CR) ATS410=? (CR) Get the encryption key
ATS411=mode ATS411=?	Payload encryption	Set or Get the device payload encryption mode. <mode>: [ 0:Payload Encryption OFF, 1:Payload Encryption ON}  Ex) ATS411=1 (CR) ATS411=? (CR) Get payload encryption