

ARM-N8-LRW

USER GUIDE



Transceiver 868MHz : 14/20dBm



General information:

- Frequency: 868MHz, 915MHz
- **LoRaWAN**
- **LoRa P2P**
- Standalone
- RF data rate: 100 to 10000 bps
- Modulation: CSS
- Output power: 2 to 20 dBm
- Sensitivity: -142 dBm
- Link budget: 161dB
- Range up to: 25km
- Interface: UART
- Dimensions: 30mm x 18mm
- Certified: EN 300 220
- Operating temperature: -20°C /+85°C

Typical application:

- Internet Of Things (IoT)
- Environment
- Intelligent structures
- Telemetry
- Alarm and wireless security systems
- M2M
- Remote sensors

Document Information

File name	EN-UG -ARM-N8-LRW
Created	04/07/2018
Total pages	62

Version	Notes	Firmware supported
V1.1	First preliminary release (2018-07-04 TDX)	ARM-N8-LRW_3-2-3_ACW-RTU_v2-0-0_BL_ENC.bin
V1.2	Second preliminary release (2018-12-10 TDX)	ARM-N8-LRW_3-2-3_ACW-RTU_v2-0-0_BL_ENC.bin



SUMMARY

1	GENERAL DESCRIPTION	6
2	Technical features	7
2.1	BLOCK DIAGRAM	7
2.2	Dimensions	7
2.3	Pinout	8
2.4	Electrical characteristics	9
2.5	Link interfaces	9
2.6	Power supply	9
2.7	Impedance of the antenna MATCHING	10
2.8	FOOTPRINT AND GROUND PLAN	10
2.9	ELECTROSTATIC DISCHARGE	11
2.10	Material information	11
2.11	RECOMMENDED SOLDERING REFLOW PROFILE	11
2.12	Moisture sensitivity	12
3	Overall organization	13
3.1	LoRa M2M	13
3.2	LoRaWAN	13
3.3	Transparent UART/RF BRIDGE	13
3.4	Standalone mode	13
3.5	COMMAND MODE	14
	Distant	14
3.6	TEST MODE	14
4	Device organization	15
4.1	Memory	15
4.1.1	Memory footprint and buffers	15
4.2	Registers	16
4.2.1	Registers organization	16
5	Main parameters (LORA M2M & LORWAN)	18
5.1	UART	18
5.1.1	AT commands	18
5.2	Transparent UART/RF BRIDGE	19
5.3	Low Power mode	19
5.4	Delays	21
5.5	Postamble	22
5.6	Led behavior	22
5.7	Test mode	22
5.7.1	Battery level (ATT08)	23



RSSI reader (ATT09)	23
Continuous RSSI reader (ATT0A)	23
5.7.2 Periodic emission (ATT0E).....	23
5.8 CONFIGURATION:.....	24
6 LoRaWAN.....	26
6.1 Generalities	26
6.1.1 • Bidirectional endpoint (Class A):.....	27
6.1.2 • Bidirectional endpoint with programed receive windows (Class B):.....	27
6.1.3 • Bidirectional endpoint with continuous reception (Class C):	27
6.2 Communication	27
6.2.1 • UnConfirmed frame:.....	27
6.2.2 • Confirmed frame:.....	27
6.3 Radio frequencies characteristics.....	28
6.4 Radio.....	28
6.4.1 Choosing the LoRaWAN class	28
6.5 Main parameters	28
6.5.1 OTAA process	30
6.5.2 Advanced parameters	30
6.6 LoRaWAN parameters (Read only).....	34
6.7 Advanced options	35
6.7.1 DL_REC fonctionnality	35
6.7.2 EMIT_CYCLE fonctionnality.....	36
6.7.3 Alive frame.....	36
6.7.4 Logs	37
6.7.5 <i>Examples</i>	37
7 lora p2p.....	38
7.1 RF Specification.....	38
7.1.1 REVERSAL TIME.....	39
7.2 UART Configuration.....	39
7.3 Serial buffers	40
7.4 Transparent (SERIAL/RF BRIDGE).....	42
7.4.1 Configuration	42
7.4.2 Functioning	42
VariablePacket.....	43
7.5 MAIN PARAMETERS	44
7.5.1 RF CONFIGURATION IN P2P MODE	44
7.5.2 Low Data Rate Optimization	45
7.6 LoRaTM Packet Structure.....	46



7.6.1	Preamble	46
7.6.2	Variable packet LoRa-Header Mode.....	46
7.6.3	Fixed packet LoRa-Header Mode	46
7.6.4	SyncWord	47
7.6.5	Low Data Rate Optimization.....	47
7.6.6	Lora-Payload	47
7.6.7	Address.....	48
7.6.8	User payload	49
7.7	LBT (Listen Before Talk).....	49
7.8	LBT&AFA (Adaptative Frequency Agility).....	50
	<i>Exemple :</i>	50
7.9	SNIFF MODE	51
7.10	Repeater	52
7.10.1	Unidirectional configuration:.....	52
7.10.2	Bidirectional configuration:.....	52
7.11	Description of the Registers.....	53
7.12	Radio channels	54
7.13	test MODE.....	56
7.13.1	PING PONG MODE:	56
7.13.2	RSSI READING: ATT0A/ATT02 OR ATS000=0A/ATS000=02	57
7.13.3	PUR CARRIER MODE: ATT04 or ATS000=04	57
7.13.4	CONTINUOUS MODULATION: ATT07 or ATS000=07	58
7.13.5	TRANSIENT MODE: ATT08 or ATS000=08.....	58
7.14	EXAMPLE	59
7.14.1	RX MODE WITH RSSI READING	59
7.14.2	ADRESS MODE.....	59
7.14.3	REPEATER IN BIDIRECTIONAL CONFIGURATION+ADRESS MODE	61

1 GENERAL DESCRIPTION

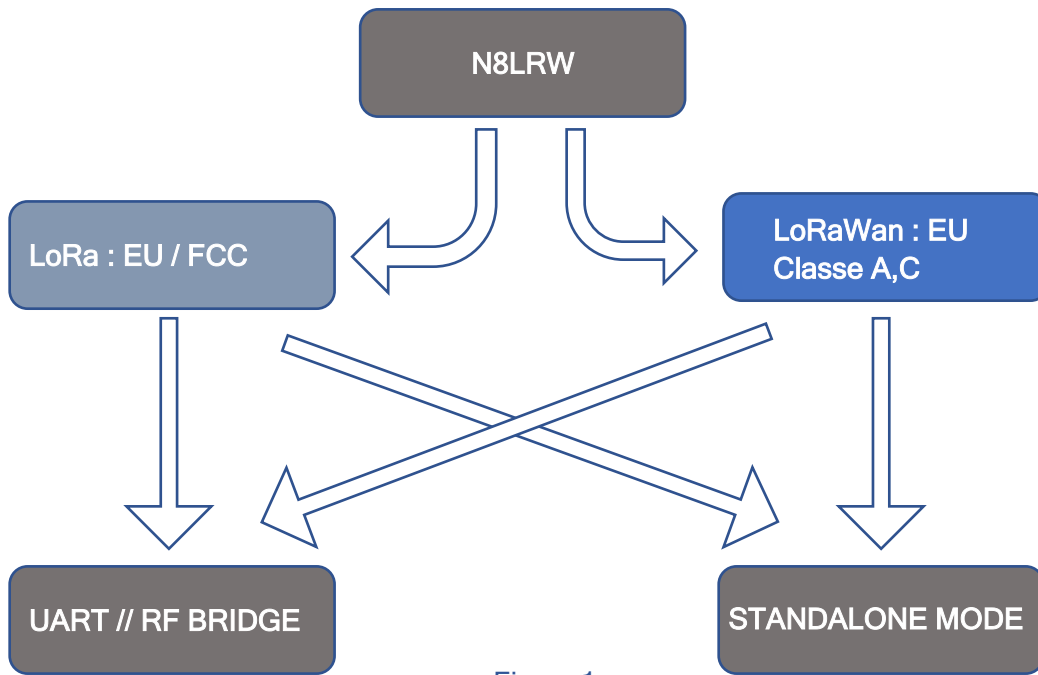

Figure 1

The N8-LRW is a radio module using LoRa modulation that guarantees high immunity to interference, and a very low sensitivity in reception. These characteristics which make it possible to reach a very long range.

The N8-LRW is a dual-mode module, capable of working on both LoRaWAN and Lora M2M. It can be operated under M2M or LoRaWAN modes, or under both modes simultaneously. Under LoRaWAN, the module can be used in either class A or class C. Under Lora M2M, the module can be operated in ENSI or FCC.

The N8-LRW module is pin-to-pin compatible with other modules from ATIM. It has taken over all features of the ARM N8-LW model. **Other UART / BRIDGE mode,** the N8-LRW embarks a so-called "Standalone" mode, enabling users to directly connect it to sensors without going through an external microcontroller. You will find usage examples on a note app. The Standalone mode allows for the integration of a new connected device in a very short time, even for users not familiar with embedded programming. The Standalone mode can be used under both LoRaWAN and LoRa P2P.

2 TECHNICAL FEATURES

2.1 BLOCK DIAGRAM

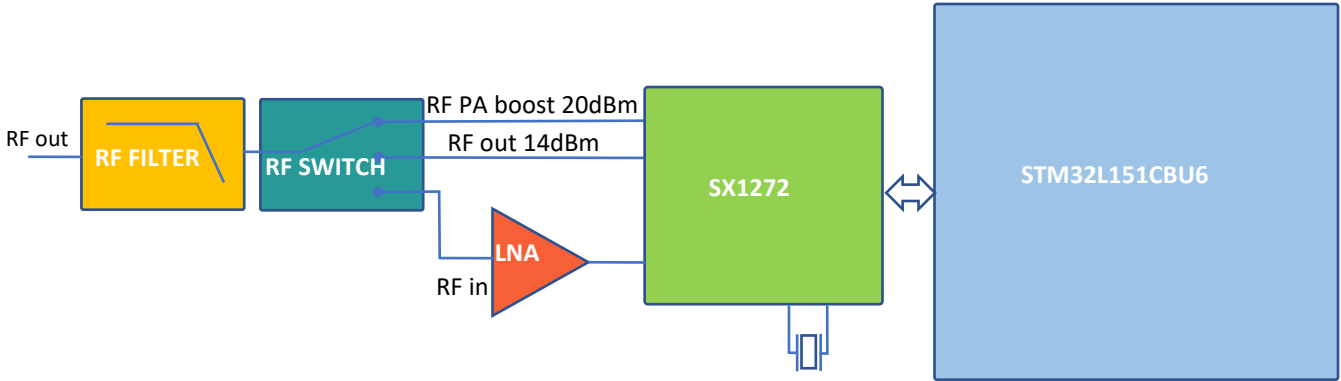

Figure 2: Module schematic

The N8-LRW module features very high RF performances. Thanks to very low noise level generated by the LNA component, module's sensitivity is -142dBm (BW = 125kHz, SF = 12), while most modules available on the market have a sensitivity of -137dBm.

By using both the RF PA Boost output and the RF Out output of the SX1272, users will have the choice to operate at 20 or 14dBm without over-consumption.

2.2 DIMENSIONS

All ARM-Nx-xxx modules are footprint compatible and share the same dimensions.

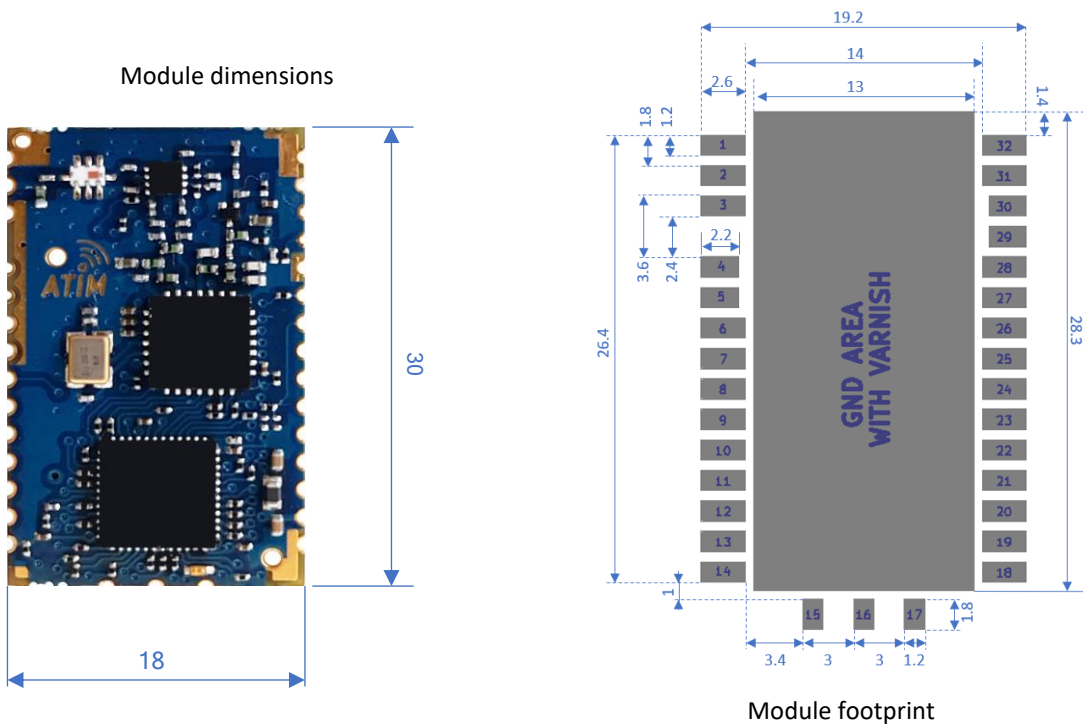

Figure 3



Figure 3 shows the ARM-N8-LWR module dimensions. Dimensions are in mm.

The N8-LRW has the same size as other models from ATIM range and keeps the compatibility of all the essential pins. By choosing the footprint of the N8LRW, you can use any ATIM N8 module.

2.3 PINOUTS

Table 1 below describes pin allocation according to the layout on Figure 2. Some pins are currently reserved for future development.

Table 1 pin allocation

Pin	Name	I/O	Function
1	AGND	-	Ground (1)
2	ANTENNA	I/O	RF signal
3	AGND	-	Ground (1)
4	GPIO0	O	STA_DO_0
5	GPIO1	O	STA_DO_1
6	AGND	-	Ground (1)
7	GPIO2	I	STA_CPT_0
8	GPIO3	I	STA
9	GPIO4	-	NC
10	GPIO5	-	NC
11	GPIO6	-	NC
12	GPIO7	-	NC
13	GPIO8	I	STA_ADC_0
14	DGND	-	Ground (1)
15	GPIO15		NC
16	GPIO16		NC
17	GPIO17		NC
18	DGND	-	Ground (1)
19	VDD	-	Power supply
20	WAKE-UP	I	Wake-up input Can be NC if not used
21	GPIO9	I	STA_DI_1
22	GPIO10	I	DL_REC / RTU_ON
23	U1RX	I	RX UART
24	U1TX	O	TX UART
25	GPIO11	-	STA VSensEN
26	GPIO12	I	STA_DI_2
27	nReset	I	Hardware reset, active when set to GND It is advised to be connected to VDD, can be NC if not used
28	AGND	-	Ground (1)
29	GPIO13	-	NC
30	GPIO14	O	STA_DO_2
31	AGND	-	Ground (1)
32	AGND	-	Ground (1)

STA:Standalone

2.4 ELECTRICAL CHARACTERISTICS

Following values in table 2 have been measured on pre-series devices, and do not correspond to the series. They will be soon updated to describe electrical characteristics of the series.

Table 2 : Electrical ratings

		Min.	Typ.	Max.
Power Supply (Vdd)		3V	3.3V	3.6V
Consumption (Vdd = 3.3V)	Tx / 14dBm	45 mA	50 mA	56 mA
	Tx / 20dBm	-	150	160
	Rx	20 mA	22 mA	24 mA
	Veille	0.5 μ A	0.6 μ A	0.9 μ A
Input voltage		Gnd	-	0.2 xVdd
Output voltage		0.8 x Vdd	-	Vdd

2.5 LINK INTERFACES

- UART 2 wires + flow control by RTS/CTS (1200 – 230400 bps)
- SPI Slave (≤ 2 MHz)
- 1 wake up input
- 1 digital output « signalization »
- 1 analog output 12 bits (option)
- functioning mode:
 - Transparent mode « UART/RF bridge » or « SPI/RF bridge »
 - Repeater mode M2M; M2M/LoRaWAN
 - Standalone mode
 - Configuration mode « AT » local and distant
 - Test modes: Ping-pong, pure carrier, continuous request, RSSI reading

2.6 POWER SUPPLY

The module's power supply is between 2,7V and 3,6V. To ensure good filtering of power supply, the LC filter must be positioned as close to the pin VDD as possible.

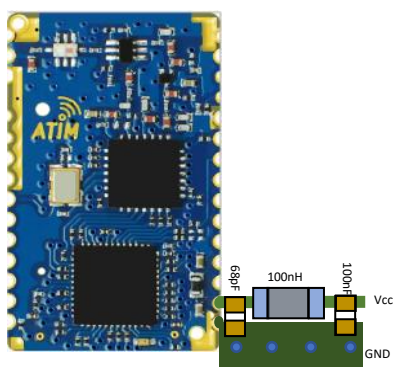

Figure 4: Power supply filter

2.7 IMPEDANCE OF THE ANTENNA MATCHING

Passive components to be integrated between the antenna and the RF pin of ARM-Nx module depend on the length of the electronic track, of the dielectric and of the chosen antenna. For a quick implementation, a 68pF serial condenser can be used. Other components are optional and do not need to be wired.

It is important to keep these components in Pi to be able to modify impedances in case the antenna was not correctly adapted.

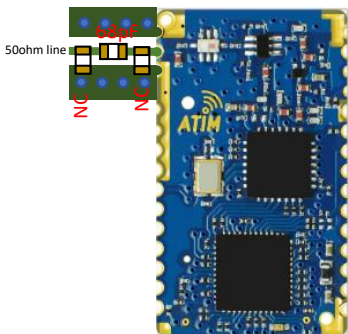

Figure 5: Impedance matching

2.8 FOOTPRINT AND GROUND PLAN

It is recommended to cover the whole surface underneath ARM-Nx modules with a ground plan. This surface must be varnished to avoid any short circuit. It is advised not to put any vias on this surface nor to use overvarnished vias.

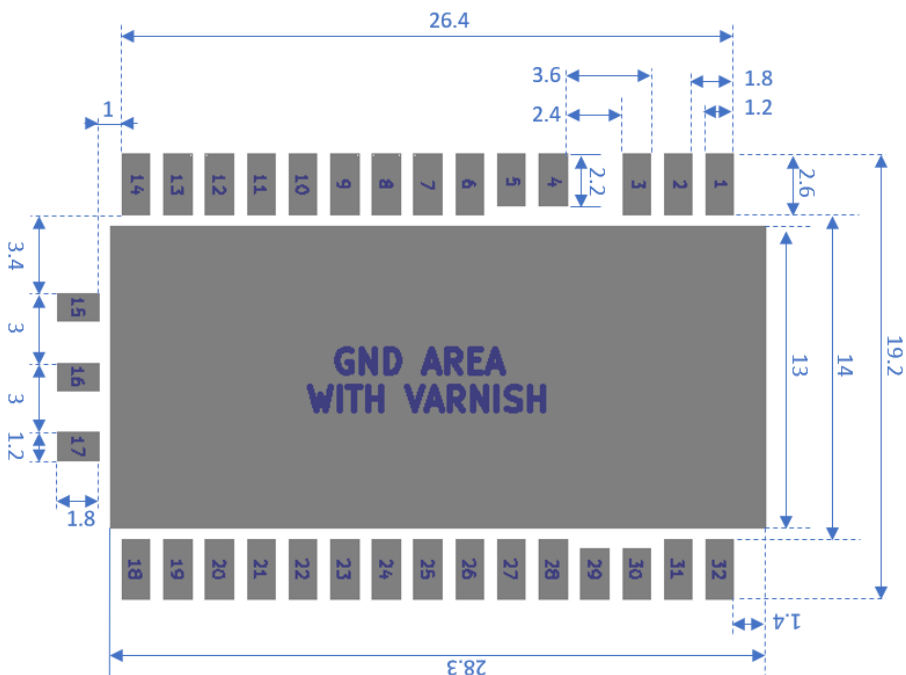

Figure 6: Footprint and ground plan

2.9 ELECTROSTATIC DISCHARGE

ARM-Nx modules are sensitive to electrostatic discharge and must be handled in accordance with JESD625-A.
 Note: JEDEC standards are available free of charge on the JEDEC website <http://www.jedec.org>.

2.10 MATERIAL INFORMATION

This product is free of environmental hazardous substances and complies with 2002/95/EC. (RoHS directive).

RoHS documentation is available on request

Contact surface: gold over nickel

2.11 RECOMMENDED SOLDERING REFLOW PROFILE

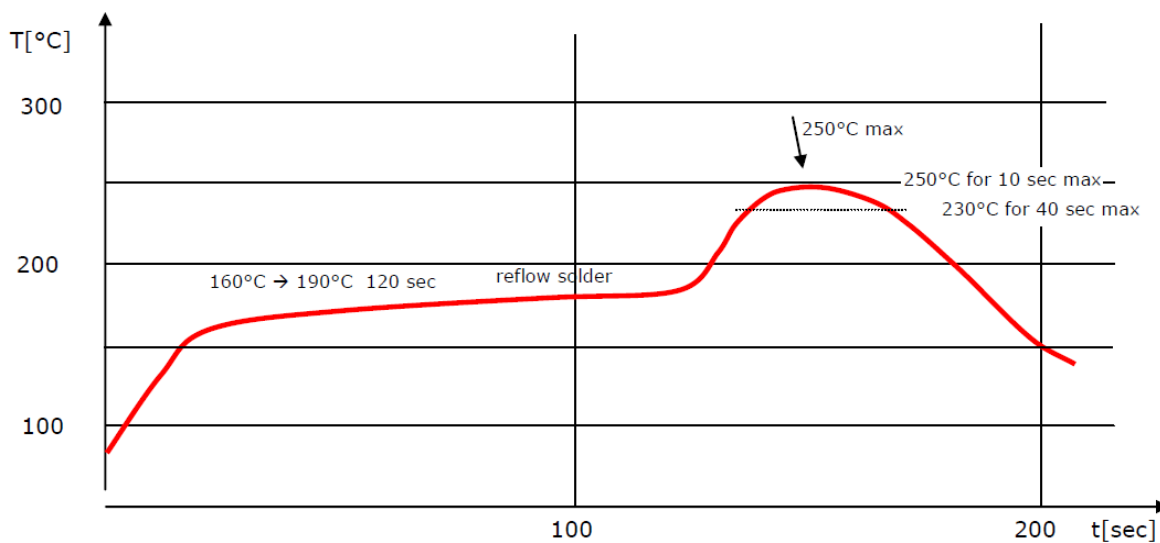

Figure 7: Reflow profile

Notes:

- ARM N8 should be soldered in upright soldering position.
- Never exceed maximum peak temperature
- Reflow cycle allowance: 1 time
- This device is not applicable for flow solder processing
- This device is applicable for solder iron process with following soldering criteria:
 - Use solder iron at or below 350°C
 - Soldering time: < 3 sec.
 - Pause between two soldering points: 3 sec.



2.12 MOISTURE SENSITIVITY

This device must be pre-baked before entering reflow soldering process. Disregarding this recommendation may cause destructive effects, such as chip cracking, leaving the device non-functional!

Shelf life	6 months, sealed
Pre-baking recommendations	12 hrs. at 60°C
Floor life (time from pre-baking to soldering process)	<72 hrs.

3 OVERALL ORGANIZATION

3.1 LORA M2M

LoRa M2M allows point-to-point or point-to-multipoint communication with a long range, ranging from 15km at 14dBm up to 35km at 20dBm. In some situations, users have been able set a communication beyond 100km. It is possible to significantly increase the range in constrained area by installing other modems as “signal repeaters”.

Unlike LoRaWAN mode, the M2M protocol allows for a device to operate in “sniff mode” in order to permanently listen with ultra-low power consumption.

Configurations are essentially through ATM and ATS commands

3.2 LORAWAN

LoRaWAN is a telecommunication protocol that enables low-speed radio communication of low-power objects that communicate using LoRa technology and connect to the network via gateways, thus contributing to the Internet of Things. Configurations are essentially ATM and ATO commands

3.3 TRANSPARENT UART/RF BRIDGE

In this mode, incoming data on the Rx UART pin are packetized with LoRaWAN or Lora M2M headers in order to be sent by radio. The payload received and available on the gateways or on a other device is the same as the previous one entering UART.

3.4 STANDALONE MODE

Stand Alone mode allows a user who has no knowledge of embedded electronics to design an IOT product in the shortest time. It works in LoRa M2M and MoRa M2M. The module has many inputs and outputs that can be modified by AT commands in UART, or by the graphical configurator. This mode allows users to make sensors extremely fast. Configurations are essentially ATO commands

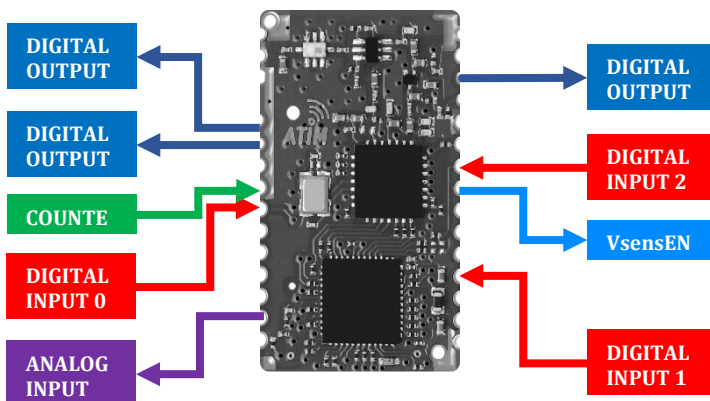

It gives users control on:

- 3 Digital Inputs (DI)
- 1 Counter (CPT)
- 1 Analog Input (ADC)
- 3 Digital Outputs (DO)
- 1 Sensor Power Enable



For advance details on this mode consult the application note ATIM_ARM-N8-LW_AN-RTU_EN.

3.5 COMMAND MODE

Local

Entering command mode can be done in two ways:

- 1 Sending three '+' characters consecutively when the device is in normal mode. This method will send the two first characters by radio.
- 2 Sending three '+' characters in one frame when the device is in normal mode. This method does not send the first two characters by radio.

Once in this mode, every data entering the UART will be considered to be an AT command.

Distant

In LoRaWAN very data received on port 160 will be considered to be an AT command. They must have the same format as those sent by serial. Do not forget to send end of line '\r' and/or '\n' at the end of the command. Parameters used are LoRaWANs.

Example:

To send the command ATV to the module by downlink, the payload need to be 0x4154560d

3.6 TEST MODE

Cf 5.7



4 DEVICE ORGANIZATION

4.1 MEMORY

There are three different memories, the RAM, the EEPROM and the Flash.

The parameters that are used by the device are stored in the RAM. Access is faster, but everything is lost when switched off. It is used by the device to store parameters when running.

EEPROM as a slower access but is able to keep parameters even after it is switched off. It is used to store parameters/configuration for the device.

The Flash is a read only memory. It's used to store firmware and factory configuration to restore parameters if needed.

4.1.1 Memory footprint and buffers

Table 3 display the global memory organization.

Table 3: Global memory organization

Function	Memory type	Capacity (Bytes)
Firmware	Flash	64k
AT parameters saved (ATM, ATO, IDs)	EEPROM	-
AT parameters in use (ATM, ATO, IDs)	RAM	-
Buffer UART Rx	RAM	256
Buffer UART Tx	RAM	256
Buffer Radio Rx	RAM	256
Buffer Radio Tx	RAM	256
Buffer command mode Rx	RAM	128
Buffer command mode Tx	RAM	256

Every data entering the Rx Uart will be redirected into buffer corresponding to the current mode, Tx Radio or Rx AT.

Every data received by radio (Rx Radio) and coming from the command mode (Tx AT) will be redirected on the Tx Uart.

Uart Rx buffer can accept up to 256 Bytes. If user overflow the buffer, there will be data lost. Data flow control CTS/RTS should be implemented in a future version.

Radio Tx buffer can stack up to 32 messages for a maximum size of 256 Bytes (sum of every messages). If user overflow one of them, there will be data lost. This issue will be corrected in a future version.

AT Rx can only stack one AT command at the time, up to 128 Bytes. If an AT command arrive while the operation of the previous one is not done yet, the last one entered will be lost.

4.2 REGISTERS

There are three main structures of data in memory: the device configuration, user parameters, and the IDs.

The device configuration is accessible in Read/Write by ATM command (M). It is mainly used to store device configuration, like parameters defining if it's configured to use LoRa or LoRaWAN radio, to choose the LoRaWAN class, to configure UART transmission, etc.

User parameters are accessible in Read/Write by ATO command from 75 to 96 (O Param). Mainly used to configure radio parameters like spreading factor, emission power, channel, and activate Rx windows, ADR, duty cycle, etc.

IDs are accessible in read only by ATO command from 0 to 74 (O IDs).

4.2.1 Registers organization

The memory footprint is visible in the Figure 8. It explains how all the structures are stored, and how they can be accessed.

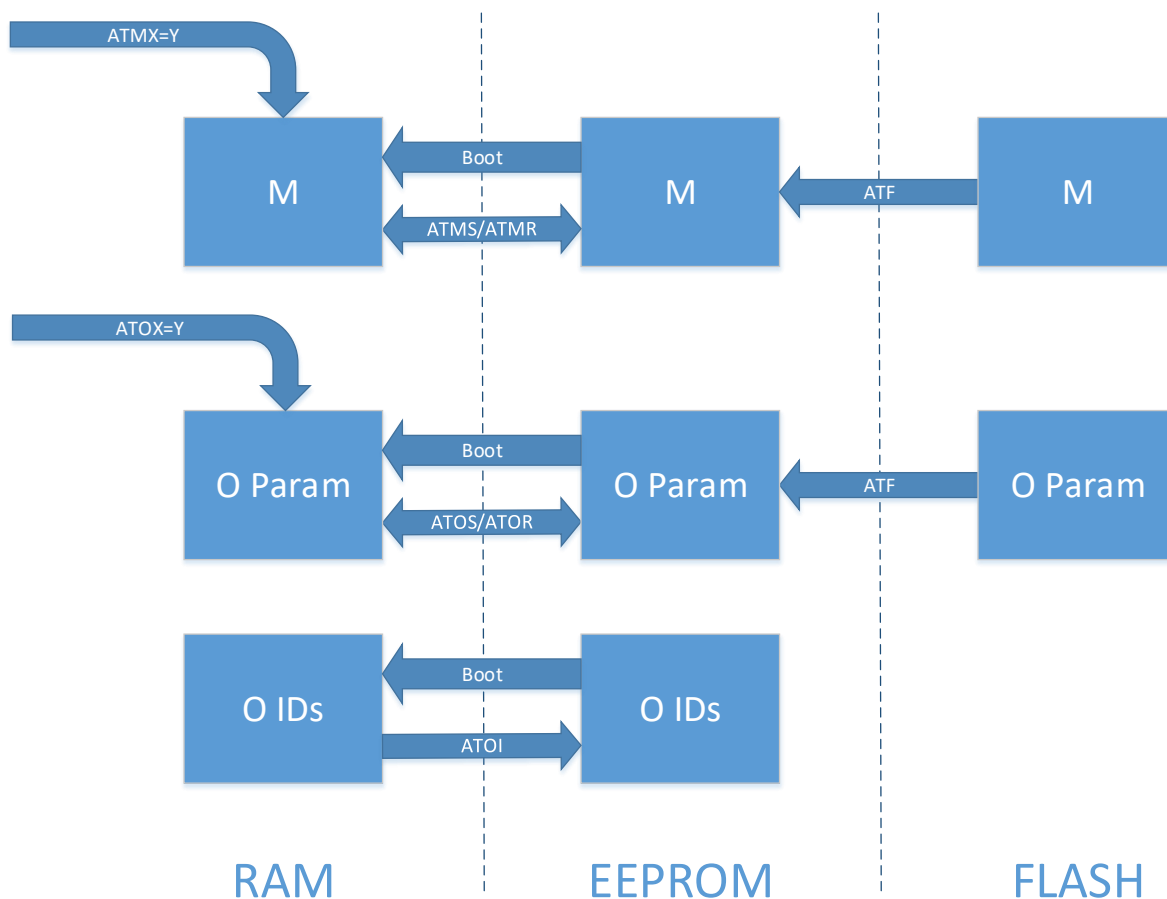

Figure 8: Memory access and organization

The device uses RAM structure.

EEPROM structures are used to store user configuration. They are loaded in RAM structure each time the device boots up. Therefore, EEPROM structures are used to initialize and configure the device at every boot.

The structures can be accessed with AT commands

An ATM command will change the corresponding parameter value in the RAM structure. ATMS command is the only way to save this structure in EEPROM

An ATO command will change the corresponding parameter value in the RAM structure. ATOS command is the only way to save this structure in EEPROM



Factory settings can be restored with ATF command; it will load EEPROM structure with the one configured in Flash. IDs aren't changed by this command.

User can restore EEPROM structure in RAM, or save the RAM structure in EEPROM with command ATMS, ATMR, ATOS and ATOR. It allows to test a configuration, change RAM values and saving it after in EEPROM all parameters at once, or restoring EEPROM configuration if needed.



5 MAIN PARAMETERS (LORA M2M & LORWAN)

5.1 UART

UART communication can be configured with ATM command from 007 to 012. It is important not to forget to save the configuration entered with ATMS command.

There is two ways to apply modifications. The first one is to use the command ATIU to only reset the UART. The second one is to reset the module Reset, it can be hardware or software via the command ATR.

Table 4: Uart configuration, AT commands

ATM	Bit	Parameter	Register value
007	0:7	Baudrate UART	600 bps = 0x00, 1200 bps = 0x01, 2400 bps = 0x02, 4800 bps = 0x03, 9600 bps = 0x04, 14400 bps = 0x05, 19200 bps = 0x06, 38400 bps = 0x07, 56000 bps = 0x08, 57600 bps = 0x09
008	0:7	Wordlength	0x00: 8 bits, 0x01: 9 bits
009	0:7	Parity	0x00: no parity, 0x01: even parity, 0x02: odd parity
010	0:7	Stop bits	0x00: 1 stop bit, 0x01: 0.5 stop bit, 0x02: 2 stop bit, 0x03: 1.5 stop bit
011	0:7	Flow control	0x00: no flow control, 0x01: rts flow control, 0x02: cts flow control, 0x03: rts/cts flow control
012	0:7	Timeout char	0xMM: 0xMM char to wait for timeout

5.1.1 AT commands

Table 5 :AT commands

Command	Function
+++	Enter in AT command mode. (IN SERIAL ONLY)
\$\$\$	Enter in AT command mode. (IN OTA ONLY)
ATQ + ENTER	Exit AT command mode.
ATR + ENTER	Reset MCU.
ATM'XXX' + ENTER	Read MXXX register, XXX decimal value.
ATM'XXX'='YY' + ENTER	Write MXXX register, XXX decimal value, YY hexadecimal value, Write in RAM structure.
ATMS + ENTER	Save ATM structure from RAM to EEPROM.



Command	Function
ATMR + ENTER	Restore ATM structure from EEPROM to RAM.
ATO'XXX' + ENTER	Read OXXX register, XXX decimal value.
ATO'XXX'='YY' + ENTER	Write OXXX register, XXX decimal value, YY hexadecimal value, Write in RAM structure.
ATOS + ENTER	Save ATO user parameters structure from RAM to EEPROM.
ATOR + ENTER	Restore ATO user parameters structure from EEPROM to RAM.
ATOI + ENTER	Save IDs structure from RAM to EEPROM.
ATF + ENTER	Restore factory parameters for ATM and ATO structure. Does not change IDs. It is best to restart module with ATR or by hardware connection for some parameters to take effect, (eg: module configuration)
ATV + ENTER	Return module type, firmware revision, radio band used, DevEUI (LSB first) and LoRaWAN version.
ATVV + ENTER	Return ATV and old firmware revision format.
ATL'XXX' + ENTER	List parameters for a structure. XXX can be: O to list ATO user parameters structure and IDs, M to list ATM structure,
ATT'XX' + ENTER	Launch test mode XX, XX hexadecimal value.
AT\$SB='X' + ENTER	Send X as a frame, X can be 0 or 1.
AT\$SF='XXX' + ENTER	Send XXX as a frame, XXX can be the size of a normal frame.
ATI'X' + ENTER	'X' can be B to empty all buffers; all data are lost, U to restart Uart, apply configuration bytes changes, R to restart radio layer, apply configuration bytes changes, resets data.

5.2 TRANSPARENT UART/RF BRIDGE

In this mode, incoming data on the Rx UART pin are packetized with LoRaWAN or Lora M2M headers in order to be sent by radio. The payload received and available on the gateways or on a other device is the same as the previous one entering UART.

5.3 LOW POWER MODE

Low power mode is used to achieve the lowest power consumption possible. When it is sleeping the device cannot be accessed in any way, it has to be woken up before.

When the mode Low Power is on, it can be configured to be controlled with the Wake Up pin or the Uart Rx pin.

A quick summary of these modes is displayed in Table 6. Further details are in followings parts 0 page 20, and 0 page 21.

Table 6: Low Power mode summary

Wake up configured on:	Wake Up pin	Uart Rx pin
Waking up if:	Device is sleeping and there is a rising edge on the Wake Up Pin.	Device is sleeping and there is a falling edge on Uart Rx Pin
Waking up time	Min 13 ms, typical 15 ms	Min 13 ms, typical 15 ms

Stay awake if:	Wake Up pin set to '1' or something to do ¹ .	Something to do.
Go to sleep if:	If Wake Up pin set to '0' and nothing to do ² for 10 ms.	If nothing to do for 100 ms.

It is important to know that the device will finish his emission cycle Tx/Rx before going to sleep.

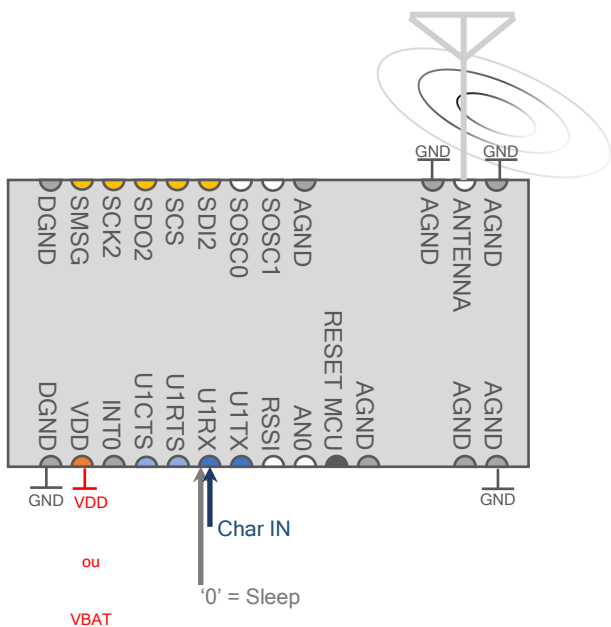

Figure 9

WAKING SOURCE: WAKEUP PIN

When the mode Low Power is on and configured to be controlled with the Wake Up pin, it responds to the following cycle.

- If the WakeUp pin is set to '1' the device will stay awake.
- If the WakeUp pin is set to '0' the device will go to sleep after 10 ms without actions.
- If there is a rising edge and the device is sleeping, it will awake.
- If there is a rising edge and the device is running, it will continue running.

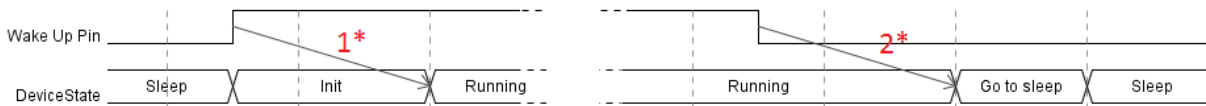

Figure 10: Timing for Low Power On, programmed to wake up on wake up pin

Figure 10 shows a chronogram of the device state when configured to wake up on the Wake Up pin. The device will go in sleep mode after 10 ms without any actions (eg: 2*). When sleeping, it will be awoken by rising edge on the Wake Up pin (eg: 1*).

¹ Something to do: The device has something to do when it is in command mode or it has an emission cycle running or there is undealt data in a buffer.

² Nothing to do: The device has nothing to do when it is not in command mode and it has no running emission cycle and every buffers are empty (every data has been dealt with).

Every data sent to the device by any way³ during initialisation mode (before Running mode) will be lost. Minimum time and typical time to wait are displayed in Table 7: Timing table page 21.

WAKING SOURCE: UART RX PIN

Wake up on Uart is not native. It is advised to wait around 20 ms after waking it up to be sure that the device is awoken before trying to communicate with it.

When the mode Low Power is on and configured to be controlled with the Uart Rx pin, it responds to the following cycle.

If the device is running, it will go to sleep after at least 100 ms without any actions.

If there is a falling edge and the device is sleeping, it will awake.

If there is a falling edge and the device is running, it will be dealt as an incoming Uart communication.

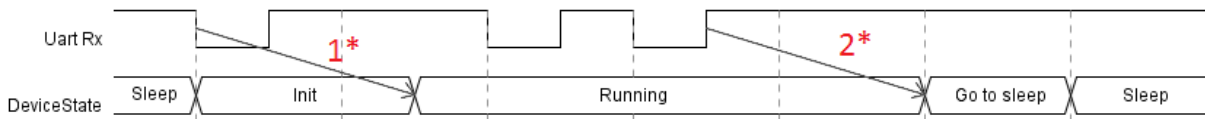

Figure 11: Timing for Low Power On, programmed to wake up on Uart Rx pin

Figure 11 shows a chronogram of the device state when configured to wake up on Uart Rx pin. The device will go to sleep mode after 100 ms without any actions (eg: 2*).

When sleeping, it will be awoken by falling edge on the Uart Rx pin (eg: 1*). It is necessary to send character null (0x00) to awake device.

Every data sent during initialisation mode (before Running mode) will be lost. Minimum time and typical time to wait are displayed in Table 7: Timing table page 21.

5.4 DELAYS

(TBD)

Following delays values are not available. They will be measured with future batches.

Table 7: Timing table

		Delay		
		Min	Typical	Max
Boot	-	13 ms	15 ms	(TBD)
UART buffering	-	(TBD)	(TBD)	(TBD)
UART input to Tx output	LoRaWAN	(TBD)	(TBD)	(TBD)
Rx input to UART output	LoRaWAN	(TBD)	(TBD)	(TBD)
Radio transition time	Tx-Rx or Rx-Tx	(TBD)	(TBD)	(TBD)
Command mode	Entering AT (+++)	(TBD)	(TBD)	(TBD)
	Quitting AT (ATQ)	(TBD)	(TBD)	(TBD)
	Reset (ATR)	(TBD)	(TBD)	(TBD)
Sleep mode	Entering	Normal (Wake)	(TBD)	(TBD)

³ Eg: by radio or by serial



		Up): 10 ms Uart: 100 ms		
	Quitting (waking up)	13 ms	20 ms	(TBD)
Bootloader	Firmware up to 54 KB	50s	55s	60s

5.5 POSTAMBLE

The postamble functionality allow user to preconfigure data to be set at the end of every radio frames.

ATO130 set the size of the postamble data to send from 0 to 31, and the mode to use, to concatenate with outgoing frames or to replace them.

ATO131 to ATO 161 store the postamble data. It will be used starting from ATO131 up to 161.

Table 8 : Postamble configuration

ATO	Bit	Parameter	Register value
130	0:4	Size to send	0xYY: Size of the data to use
	5:6	Unused	
	7	Replace message	0: Postamble is set at the end of the current frame 1: Postamble replace the current frame
131-161	0:7	Postamble data	Postamble data

Example:

ATO131=AA, ATO132=BB, ATO133=CC, ATO134=DD, ATO135=EE

The device is requested to send a frame with the payload 0x223344, the frame sent will be:

1. if ATO130=03, payload sent = 0x223344AABBCC
2. if ATO130=82, payload sent = 0xAABB

5.6 LED BEHAVIOR

ATM002 allow users to configure the Led behavior. Bit 0 to 3 are used to choose if the Led has to get a particular value in this state. Bit 4 is used to define the value taken by the Led during these specified states, other times it will be the complement. EG: to get the Led to turn on during Tx an Rx, and be off all others times, ATM002 value has to be 0x1C. To get the led always on and turn off during Tx and Rx, ATM002 value has to be 0x0C.

Table 9: Led behavior configuration

ATM	Bit	Parameter	Register value
ATM002	4	Led default state	0: Led off during chosen states, on other time 1: Led on during chosen states, off other time

5.7 TEST MODE

Test mode allows you to use various functions to test the device, or the network.



To launch a test mode, enter in command mode. Choose the test mode with ATTxx ('xx' in hexadecimal). Send any characters to start the test. If this is a continuous test, it can be stopped by sending any character. Quitting a test mode voluntarily or after its execution will set the device in command mode.

It is recommended to restart the device after using a test mode that used the radio.

Table 10: Test mode list

ATT	Test mode
08	Battery level
09	RSSI Reader
0A	Continuous RSSI reader
0E	Periodic emission
10	Test mode reserved for RTU ⁴ purpose.

5.7.1 Battery level (ATT08)

Return the battery level.

Eg:

```
ATT08
BATTERY: 0xFE
```

RSSI reader (ATT09)

Return the RSSI level.

Eg:

```
ATT09
-90/-91
```

Continuous RSSI reader (ATT0A)

This test mode read RSSI values, it returns an average value every 35 ms.

RSSI reader uses user parameters from ATO structure, channel (077), spreading factor (075), etc.

```
ATT0A
RSSI = -89/-91
RSSI = -90/-91
RSSI = -90/-91
RSSI = -91/-91
```

5.7.2 Periodic emission (ATT0E)

⁴ For advance details on this mode consult the application note ATIM_ARM-N8-LW_AN-RTU_EN.



This test mode will periodically send message to the radio layer. The period is define by user,

The command format is ATTOE=xx , where xx is the hexadecimal value of the period in seconds. The minimum emission time is 5 second, any value under will activate an emission every 5 seconds.

The following command will trigger an emission every 10 seconds:

```
ATTOE=0A
```

5.8 CONFIGURATION:

ATM Configuration

REGISTER	DESIGNATION	DESIGNATION VALUES	DEFAULT VALUE	READ/WRITE
ATM00	Module Configuration	M2M / LoRaWAN : 1 Modulation FSK/LoRa: 1 if b0=0 // Repeater M2M/LoRaWAN: b1=1 and b0=1 LoRaWAN Class: 2 // 0: A; 1:B; 2:C Unused: 4	0x01	R/W
ATM01	functionnality	lowPowerOn: 1; wakeUpSource: 1; 0 pins wkup/ 1 uart wakeOnFalling: 1; 0 front montant / 1 front descendant Uart_pull : 1; 0 no pull sur uart/ 1: pull up sur uart si b2=1 else pull down STA_ON: 1 STA_OnOnlyOnReg: 1; 0 pin ou registre; 1 registre seulement RTSForDLDelay: 1; 1: 50ms of delay to wake up the external micro RSSIForEmission: 1; only for LoRaWAN, pins RSSI pass to 1 for the Tx and Rx phase if the network is joined.	0x00	R/W
ATM02	LED ON	Boot: 1; WakingUp: 1; RF Tx: 1; RF Rx: 1; OnOff: 1; Unused: 3;	0x00	R/W
ATM03	aliveFrame Periode	0: unused 1: 10s 2: 30s 3: 1min 4: 10min 5: 1h 6: 24h 7: 1week 8: 1month A: 2h B: 4h C: 8h D: 2days E: 3days If >0F 1day	0x00	R/W
ATM04	logsChar;	0 disabled else for checking	0x00	R/W



ATM05	timeBeforeSleep	0: 50ms on wk // 500ms on uart else value defined by 10ms or 1ms b1 of ATM06	0x00	R/W
ATM06	Fonctionnality 2	b0:0 no Rx during CMD AT, 1 Rx possible during CMD AT b1: ATM05 duration; 0:10ms; 1:1ms b2: 0 pll of stm32 off, 1 pll on for N8LR and N8LRW b3: _enableLocalFrame, 1:on; 0:off b5=0 M2P mode uses ATS registers; if b=1 M2M utilizes hidden config inRTU mode	0x00	R/W
ATM07	UART_BaudRate;	600 bps = 0x00, 1200 bps = 0x01, 2400 bps = 0x02, 4800 bps = 0x03, 9600 bps = 0x04, 14400 bps = 0x05, 19200 bps = 0x06, 38400 bps = 0x07, 56000 bps = 0x08, 57600 bps = 0x09	0x00	R/W
ATM08		0x00: 8 bits, 0x01: 9 bits	0x00	R/W
ATM09		0x00: no parity, 0x01: even parity, 0x02: odd parity	0x00	R/W
ATM10		0x00: 1 stop bit, 0x01: 0.5 stop bit, 0x02: 2 stop bit, 0x03: 1.5 stop bit	0x00	R/W
ATM11		0x00: no flow control, 0x01: rts flow control, 0x02: cts flow control, 0x03: rts/cts flow control	0x00	R/W
ATM12	NbCharTimeout	0:5 char else value	0x00	R/W
ATM17		b0 1: RAM (by default); 0 EEPROM charger les changements des CMD AT b1 0 pas de debug et 1 avec debugs, b2 0: PA off 1:PA ON	0x00	R/W
ATM20	ATF	0x99 pas de ATF au démarrage ni sur mise a jour 0xEE ATF à chaque démarrage else ATF sur mise à jour	0x00	R/W

6 LORAWAN

LoRa™ is a high range, low power consumption and low datarate wireless modulation developed by Semtech and supported by LoRa Alliance. LoRaWAN stack is mainly developed for battery powered devices, either fixed or mobile. It is optimized for the Internet Of Things (IOT).

6.1 GENERALITIES

Just for the record, LoRaWAN protocol is still young and evolve quickly. There is constantly modifications and adaptations to realize in order to follow these evolutions. Furthermore, with the quick start and development of the LoRa Alliance, LoRaWAN protocol changed its name from LoRaMac to LoRaWAN. This change is not yet effective everywhere, it is possible to found documents with term LoRaMac or Mac.

LoRaWAN network is typically in a Star to Star topology, see **Erreur ! Source du renvoi introuvable.** Gateways⁵ pass messages between end devices and central server network (often on the internet). Gateways are connected to the network with a standard IP connection, whereas endpoints uses single hoping communication to join one or more gateways. Every communication are usually bidirectional, even if uplinks⁶ are more frequently used than downlinks⁷.

Erreur ! Source du renvoi introuvable. shows Stars to Stars topology, in this example, network extremities are end devices, and those are linked to gateways to relay information to a central server network on the Internet.

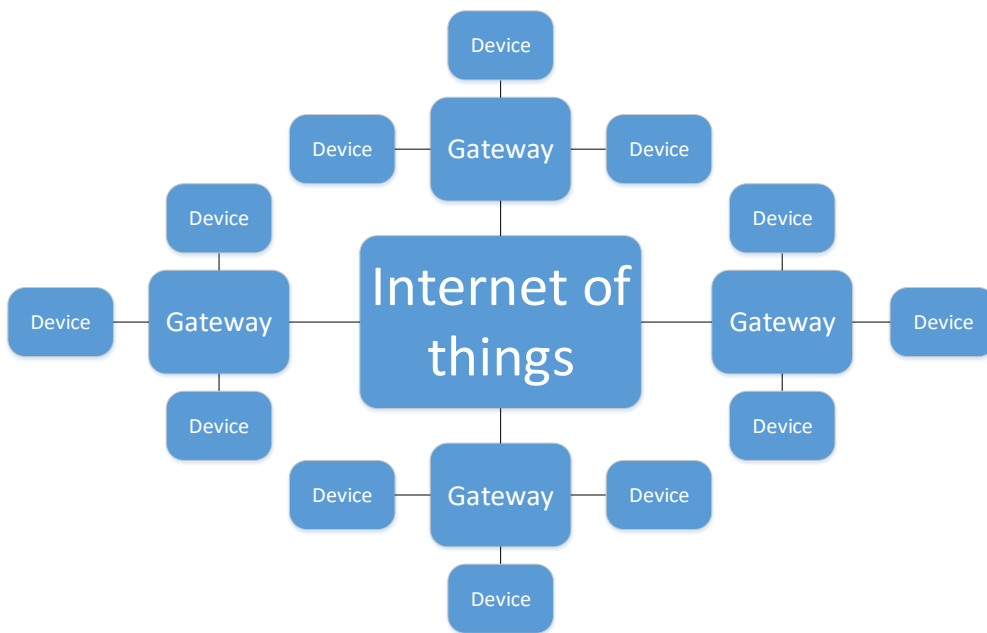

Figure 12: Stars of Stars topology

Communication between the endpoint and concentrator is possible on different frequency channels and uses different spreading factors. The channel is chosen randomly between those available, command sent by concentrator can add new channels if needed. The choice of a spreading factor is a compromise between communication range and data rate, lower data rate will achieve higher communication range. The data rate goes from 0,3 Kb/s to 50 Kb/s. To optimize

⁵ Gateway: also know under the name of concentrator or base station.

⁶ Uplink: communication from end device to the Internet.

⁷ Downlink: communication from the Internet to an end device.

battery lifetime and network overload, network infrastructure automatically adapts spreading factor and emission power for each endpoint individually, following an Adaptive Data Rate scheme (ADR).

LoRaWAN protocol defines three device classes, A, B and C. This diversity allows an answer adapted to every need. All devices implement at least functionalities of a class A device.

6.1.1 • Bidirectional endpoint (Class A):

Class A endpoint allows bidirectional communication with the applicative layer by opening two receive windows (Rx1 and Rx2) after each emission, see Figure 13.

Receive windows allows the endpoint to receive downlink communication.

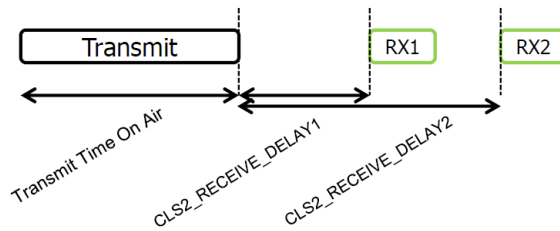

Figure 13: Class A endpoint radio scheme

6.1.2 • Bidirectional endpoint with programmed receive windows (Class B):

Class B endpoint follows Class A behavior with the functionality to open receive windows at a precise time. This window is based on temporal information given by the network structure.

6.1.3 • Bidirectional endpoint with continuous reception (Class C):

Class C endpoint follows Class A behavior on top of continuous listening on a channel. It allows endpoint with continuous power supply to be in a continuous reception when it is not emitting an uplink, see Figure 14.

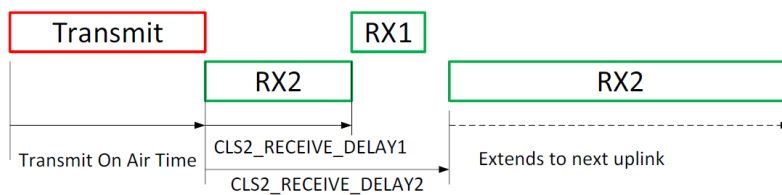

Figure 14 : Class C endpoint radio scheme

6.2 COMMUNICATION

LoRaWAN protocol allows two types of communication, allowing users to choose between UnConfirmed or Confirmed frame. The choice should be made accordingly to the application wished.

6.2.1 • UnConfirmed frame:

This type of frame does not need an acknowledgment. It means that the endpoint will emit the message the number of times it is configured to. If the message is lost there will be no re emission.

6.2.2 • Confirmed frame:



This type of frame need an acknowledgment. It means that the endpoint will emit the message and wait for an acknowledgment. If it does not receive one, it will restart a cycle, sending the frame again and waiting for the acknowledgment. The cycle will be repeated up to the number of time it is configured to.

It allows a certain level of security in the communication, to avoid information loss.

6.3 RADIO FREQUENCIES CHARACTERISTICS

Spreading factor can be configured from 12 to 7. It is a compromise between radio range and data rate. A spreading factor of 12 will reach higher range at a cost of a slower datarate, one of 7 will achieve higher data rate with a smaller range.

Rf output power can be chosen from 2 to 14 dBm. With higher output power, the device will reach longer range but will consume more energy.

Currently, the bandwidth is always 125 kHz, LoRaWAN forecast some evolution with 250 kHz and 500 kHz.

Currently, the coding rate used is always 4/5. LoRa modulation authorize coding rate from 4/5 to 4/8, future LoRaWAN evolution may be using them.

Three channels are always available, LC1: 868.1MHz, LC2: 868.3MHz and LC3: 868.5MHz. Others can be loaded via Gateway MAC command.

6.4 RADIO

6.4.1 Choosing the LoRaWAN class

This version support LoRaWAN class A and C.

In order to be effective, the configuration needs to be in RAM when the radio starts. There is two ways to do it, the first one is to reset the radio layer with 'ATIR' command. The second one is to save the configuration with 'ATMS' and restart the device.

Table 11: LoRaWAN class configuration

ATM	Bit	Parameter	Register value
000	0	Activate LoRaWAN	0: set device in default (DO NOT USE) 1: use LoRaWAN
	1:2	UNUSED	
	3	LoRaWAN Class	0 : Class A 1: Class C
	4:7	UNUSED	

Example:

ATM000=01, the device will be in Class A

ATM000=09, the device will be in Class C

6.5 MAIN PARAMETERS

Radio parameters can be configured to follow a defined behavior and to fulfil specific tasks. This configuration is the user's responsibility; they have to choose what will be the best configuration for their application.

The main ATO command is ATO083, it defines LoRaWAN behavior, allowing the user to choose if the LoRaWAN layer will:



- follow an Over The Air Activation (OTAA)
- open Rx windows after an emission
- adapt its spreading factor automatically with Wan command (ADR)
- enforce duty cycle
- switch and adapt its channel automatically
- adapt its Rx2 window following Wan command
- Define if LoRaWAN is using public or private network configuration

If ADR is on and Rx windows are off, Rx windows will be turned on. It is the same if the device is configured to send confirmed frame (see ATO080).

ATO080 configure emission, allowing users to choose between confirmed frame and unconfirmed frame. It also set the numbers of repetition for unconfirmed and the maximum repetition for confirmed ones. Note: confirmed frame have priority on unconfirmed. Set confirmed to 0 to use unconfirmed. Dans le cas de la macro geolocation utilisée par des opérateurs qui nécessite 3 trames non confirmées à chaque émission. Dans ce cas, utiliser ATO080=03.

ATO082 is used to set the application port used to communicate.

ATO086 is used to define the OTAA cycle parameters. The process is described in part 0

OTAA process page 30.

Table 12: Advanced radio parameters configuration

ATO	Bit	Parameter	Register value	Used when
080	0:3	Unconfirmed frame number of emission	0x0: will use LoRaWAN default value, can be adapt by gateway with MacCommand 0xY: send unconfirmed frame up to Y (from 1 to F)	Always
	4:7	Confirmed frame number of emission	0x0: Does not use confirmed frame, using unconfirmed 0xY: send confirmed frame up to Y (from 1 to F)	
082	0:7	Port field	0x00 : indicates that the FRMPayload contains MAC commands only, 0x01 – 0xDF : application specific, 0xA0 : Used for OTA command mode, 0xE0 : Used for LoRaWAN compliance test, 0xE1 – 0xFF : reserved for future standardized application extensions	Always
083	0	Over The Air Activation (OTAA)	0: off, will join network in ABP mode, 1: on, will join network in OTAA mode	Always
	1	Rx windows on	0: off, 1: on	
	2	Adaptive Data Rate (ADR)	0: off, 1: on	
	3	Duty cycle on	0: off, 1: on	
	4	Adaptive channel on	0: off, 1: on	
	5	Adaptive Rx2 on	0: off, 1: on	
	6	Rx2 default data rate	0: set to SF12, 1: set to SF9	

ATO	Bit	Parameter	Register value	Used when
	7	Public private network	0: set LoRaWAN public network 1: set LoRaWAN private network	
086	0:3	OTAA nb tries	0: will send each selected SF 4 times, X: will send each selected SF X times,	OTAA enabled
	4	OTAA use SF8	0: OTAA will ignore this SF 1: OTAA will use this SF	OTAA enabled
	5	OTAA use SF9	0: OTAA will ignore this SF 1: OTAA will use this SF	OTAA enabled
	6	OTAA use SF10	0: OTAA will ignore this SF 1: OTAA will use this SF	OTAA enabled
	7	OTAA use SF11	0: OTAA will ignore this SF 1: OTAA will use this SF	OTAA enabled

6.5.1 OTAA process

OTAA join request are following a cycle. Between two cycles the device will wait around 50 to 70 minutes. It reduces the number of emission and allows the device to sleep, both of it reduces the power consumption.

A cycle is composed of join requests. These join request will use at least Spreading Factor 7 and 12 (SF), the others SF can be used when selected with register ATO086. The number of tries for each SF can also be configured in the same register from 1 to 15 times.

Between two requests, the device will wait a fixed time based on SF plus a random time. It allows to enforce duty cycle (fixed part) and reduces probability of collision between multiple devices (random part). These times are displayed in Table 13.

On an unsuccessful join to a network, the device will follow its current cycle. The device will wai

On a successful join to a network, the cycle stop and the device can start to communicate with the network.

Table 13 : Waiting times depending on the last SF used

SF used	Waiting time before next join request
7	10 to 14 seconds*
8	15 to 19 seconds*
9	30 to 34 seconds*
10	50 to 54 seconds*
11	100 to 104 seconds*
12	180 to 184 seconds*

*Those timings can be affected by temperature variation and manufacturing processes.

Example:

ATO086=00, the cycle will be 4 tries SF7 and 4 SF12.

ATO086=23, the cycle will be 3 tries SF7, then 3 SF9 and 3 SF12.

6.5.2 Advanced parameters

ATO075 and ATO076 will be used for emission only if the **ADR is turned off** (bit 2 of ATO083). It allows the users to choose and fix the spreading factor and output power depending on their application needs.

Rx2 Spreading factor fixed by ATO075 will be used only if the bit 5 of ATO083 is off.



ATO080 configured emission, allowing users to choose between confirmed frame and unconfirmed frame. It also set the numbers of repetition for unconfirmed and the maximum repetition for confirmed ones. Note: confirmed frame have priority on unconfirmed. Set confirmed to 0 to use unconfirmed.

ATO081 is used to add Wan command to frames. If the ATO081 value is set to 0x02, the device will add MAC_LINK_CHECK_REQ in every frame it sends. The value has to be set to 0x00 to remove command addition

ATO082 is used to set the application port used to communicate.

ATO086 is used to define the OTAA cycle parameters. The process is described in part 0

OTAA process page 30.

Table 14: Advanced radio parameters configuration

ATO	Bit	Parameter	Register value	Used when
075	0:2	Emission Spreading factor	0x00 : DR_SF12, 0x01 : DR_SF11, 0x02 : DR_SF10, 0x03 : DR_SF9, 0x04 : DR_SF8, 0x05 : DR_SF7, 0x06 : DR_SF7H, 0x07 : DR_FSK	Bit 2 of ATO083 is off. Adaptive Datarate Off
	3:5	Rx2 Spreading factor	0x00 : DR_SF12, 0x01 : DR_SF11, 0x02 : DR_SF10, 0x03 : DR_SF9, 0x04 : DR_SF8, 0x05 : DR_SF7, 0x06 : DR_SF7H, 0x07 : DR_FSK	Bit 5 of ATO083 is off. Adaptive Rx2 Off
	6:7	UNUSED		
076	0:2	Rf output power	0x00 : Unused, 0x01 : TX_POWER_14_DBM, 0x02 : TX_POWER_11_DBM, 0x03 : TX_POWER_08_DBM, 0x04 : TX_POWER_05_DBM, 0x05 : TX_POWER_02_DBM	Bit 2 of ATO083 is off Adaptive Datarate Off
	4:7	UNUSED		
077	0:3	Emission Channel	0x00 : channel LC1, freq = 868.100 MHz, 0x01 : channel LC2, freq = 868.300 MHz, 0x02 : channel LC3, freq = 868.500 MHz, 0x03 : channel LC4, freq = 867.100 MHz, 0x04 : channel LC5, freq = 867.300 MHz, 0x05 : channel LC6, freq = 867.500 MHz, 0x06 : channel LC7, freq = 867.700 MHz, 0x07 : channel LC8, freq = 867.900 MHz, 0x08 : channel LC9, freq = 868.900 MHz	Bit 4 of ATO083 is off Adaptive Channel Off
	4:7	Rx2 Channel	0x00 : channel LC1, freq = 868.100 MHz, 0x01 : channel LC2, freq = 868.300 MHz, 0x02 : channel LC3, freq = 868.500 MHz, 0x03 : channel LC4, freq = 867.100 MHz, 0x04 : channel LC5, freq = 867.300 MHz, 0x05 : channel LC6, freq = 867.500 MHz, 0x06 : channel LC7, freq = 867.700 MHz, 0x07 : channel LC8, freq = 867.900 MHz, 0x08 : channel LC9, freq = 868.900 MHz	Bit 5 of ATO083 is off Adaptive Rx2 Off



ATO	Bit	Parameter	Register value	Used when
081	0:7	Wan command to add in next emission	0x00: none 0x02: MAC_LINK_CHECK_REQ, else : (TBD)	Always



Reception Info on UART

ATO	Bit	Parameter	Register value	Used when
084	0	Add frame size on serial	0: off, 1, on: Add one Byte, containing the frame size, in front of received message transmitted on serial	Sending received frame on serial link
	1	Add rx information on serial	0: off, 1: on: Add one Byte, containing rx information (bandwith, coding rate and SF), at the end of received transmitted on serial	
	2	Add RSSI information on serial	0: off, 1: on: Add two Bytes, containing RSSI information, at the end of received transmitted on serial	
	3	Add SNR on serial	0: off, 1: on: Add two Bytes, containing SNR information, at the end of received transmitted on serial	
	4	Add frame size on uplink	0: off, 1, on: Add one Byte, containing the frame size, in front of next uplink message to transmit	Sending an uplink
	5	Add rx information on uplink	0: off, 1: on: Add one Byte, containing last rx information (bandwith, coding rate and SF), at the end of next uplink message to transmit	
	6	Add RSSI information on uplink	0: off, 1: on: Add two Bytes, containing RSSI information, at the end of next uplink message to transmit	
	7	Add SNR on uplink	0: off, 1: on: Add two Bytes, containing SNR information, at the end of next uplink message to transmit	

LoRaConfig_2;

ATO	Bit	Parameter	Register value	Used when
085	0	Sticky command enabled	0: Sticky command mac disabled 1: Sticky command mac enabled	
	1:7	UNUSED		
086	0:3	OTAA nb tries	0: will send each selected SF 4 times, X: will send each selected SF X times,	OTAA enabled
	4	OTAA use SF8	0: OTAA will ignore this SF 1: OTAA will use this SF	OTAA enabled
	5	OTAA use SF9	0: OTAA will ignore this SF 1: OTAA will use this SF	OTAA enabled
	6	OTAA use SF10	0: OTAA will ignore this SF 1: OTAA will use this SF	OTAA enabled



	7	OTAA use SF11	0: OTAA will ignore this SF 1: OTAA will use this SF	OTAA enabled
--	---	---------------	---	--------------

6.6 LORAWAN PARAMETERS (READ ONLY)

LoRaWAN parameters can be read with ATO command in command mode. Those command are from ATO200 to ATO223. Value are returned in ASCII.

Those parameters are:

Table 15: LoRaWAN parameters (read only)

ATO	Parameter	Size	Value interpretation
200	DEVICE_CLASS	1 Byte	0: Class A 1: Class B 2: Class C
201	NETWORK_JOINED	1 Byte	0: no network 1: Network joined
202	ADR	1 Byte	0: off, 1: on
203	NET_ID	4 Bytes	LoRaWAN current NetID
204	DEV_ADDR	4 Bytes	LoRaWAN current DevAddr
205	NWK_SKEY	16 Bytes	LoRaWAN current NwkSKey
206	APP_SKEY	16 Bytes	LoRaWAN current AppSKey
207	PUBLIC_NETWORK	1 Byte	0: LoRaMac uses private network synch word 1: LoRaMac uses public network synch word
208	REPEATER_SUPPORT	1 Byte	0: off 1: on
209	UNUSED	N/A	N/A
210	UNUSED	N/A	N/A
211	CHANNELS_MASK	2 Bytes	LoRaWAN current ChannelMask
212	CHANNELS_NB_REP	1 Byte	Number of uplink messages repetitions [1:15] (unconfirmed messages only)
213	MAX_RX_WINDOW_DURATION	4 Bytes	LoRaMac maximum time a reception window stays open (in μ s)
214	RECEIVE_DELAY_1	4 Bytes	LoRaMac delay in μ s from end of Tx to Rx1
215	RECEIVE_DELAY_2	4 Bytes	LoRaMac delay in μ s from end of Tx to Rx2
216	JOIN_ACCEPT_DELAY_1	4 Bytes	LoRaMac delay in μ s from end of Tx to Rx1
217	JOIN_ACCEPT_DELAY_2	4 Bytes	LoRaMac delay in μ s from end of Tx to Rx2
218	CHANNELS_DEFAULT_DATARATE	1 Byte	0: DR_0 = SF12 - BW125 1: DR_1 = SF11 - BW125 2: DR_2 = SF10 - BW125 3: DR_3 = SF9 - BW125 4: DR_4 = SF8 - BW125 5: DR_5 = SF7 - BW125 6: DR_6 = SF7 - BW250 7: DR_7 = FSK
219	CHANNELS_DATARATE	1 Byte	Data representation is the same as ATO218.
220	CHANNELS_TX_POWER	1 Byte	
221	UPLINK_COUNTER	4 Bytes	LoRaMAC frame counter. Each time a packet is sent the counter is incremented.
222	DOWNLINK_COUNTER	4 Bytes	LoRaMAC frame counter. Each time a packet is received the counter is incremented.



6.7 ADVANCED OPTIONS

ATM001 configure functionalities like low power, wake up source, Ready To Use mode (RTU).

Bit 0 set on/off low power mode, it is off by default.

Bit 1 define the wakeup pin, set to 0 it will be the WakeUp pin (17), set to 1 it will be the Uart Rx pin (20). Pin list is available in the **Erreur ! Source du renvoi introuvable.** page **Erreur ! Signet non défini..**

Bits 2 and 3 are unused for now. It is advised to set them to 0.

Bit 4 set on/off the RTU mode⁸. Can also be activated with the pin (19). Be careful, bits 6 and 7 forbid the use of this mode.

Bit 5 allow RTU to be activated by hardware input or by ATO command only.

Bit 6 set on/off the function DL_REC to delay the transfer of received downlinks. Be careful, it prohibits the use of RTU mode.

Bit 7 set on/off the function EMIT_CYCLE to inform about ongoing emission cycle. Be careful, it prohibits the use of RTU mode.

Table 16: Various functionalities configuration

ATM	Bit	Parameter	Register value
001	0	Low power mode	0: Low power mode disable 1: Low power mode enable
	1	Low power waking source	0: Set on WakingUp pin (17) 1: Set on UartRx pin (20)
	2:3	UNUSED	
	4	RTU mode	0: RTU mode disable 1: RTU mode enable. Be careful, bits 6 and 7 forbid the use of this mode.
	5	RTU mode activation	0: Can be activated by hardware or by ATO command 1: Can be activated only by ATO command
	6	Delay Downlink	0: Function DL_REC inactive 1: Function DL_REC active. Be careful, it prohibits the use of RTU mode
	7	In emission	0: Function EMIT_CYCLE inactive 1: Function EMIT_CYCLE active. Be careful, it prohibits the use of RTU mode

6.7.1 DL_REC fonctionnalité

Upon activation of this mode, all transfers of received downlink will be delayed by 50 ms. During this time, users will be notified with the pin 19 (GPIO10), it will be set to “high” for 50 ms before transferring the received downlink. Be careful, it prohibits the use of RTU mode.

⁸ For advance details on this mode consult the application note ATIM_ARM-N8-LW_AN-RTU_EN.



6.7.2 EMIT_CYCLE fonctionnalité

Upon activation of this mode, all emission cycle will be indicated on the with the pin 22 (GPIO11), it will be set to “high” during the whole cycle (Tx, Rx windows and if needed repetitions). Be careful, it prohibits the use of RTU mode.

6.7.3 Alive frame

This mode allows the user to configure the device in order to emit periodically a pre-configured frame. The frame format is:

Table 17: Alive frame format

Byte	Value
0	0x01 (Frame header)
1	Battery level in idle most significant Byte
2	Battery level most significant Byte
3	Battery level in TX most significant Byte
4	Battery level in TX less significant Byte
5	0x64 (Unused)

Table 18: Alive frame configuration

ATM	Bit	Parameter	Register value
003	0:7	Alive Frame	0x00: Off 0x01: Approximately every 10 secs (DO NOT USE) 0x02: Approximately every 30 secs (DO NOT USE) 0x03: Approximately every 1 min (DO NOT USE) 0x04: Approximately every 10 mins (DO NOT USE) 0x05: Approximately every 1 hour (DO NOT USE) 0x06: Approximately every 1 day 0x07: Approximately every 7 days 0x08: Approximately every 30 days 0x09: Unused, will set every day 0x0A: Approximately every 2 hour 0x0B: Approximately every 4 hour 0x0C: Approximately every 8 hour 0x0D: Approximately every 2 days 0x0E: Approximately every 3 days 0x0F: Approximately every 4 days Else will set every day.



6.7.4 Logs

ATM004 allow users to gather some information about each emission and the join phase.

Table 19: Logs configuration

ATM	Bit	Parameter	Register value
004	0:7	Logs char	0: log mode inactive Else: log mode active, the parameter for the mode is this value

To activate this option, the register ATM004 as to be set to a value other than 0x00. logs will be encapsulated between two character define by users. It's the value of the register ATM004.

To deactivate this option, the register ATM004 as to be set to 0x00.

In the following, the value to encapsulate logs will be 0x26 (ASCII code for '&'). Available logs are:

Table 20: Logs format

Log	Information given	Example
Joined	The radio as joined the network and is ready to send data.	&Joined&
OK	Last emission is done and was a success.	&OK&
KO	Last emission is done and was not a success.	&KO&

Example:

If the register ATM004 is set to 0x24 (ASCII code for '\$'), each logs will follow the form '\$logs\$'.

6.7.5 Examples

If the register ATM004 is set to 0x24 (ASCII code for '\$'), each logs will follow the form '\$logs\$'.

6.7.5.1 DL_REC FUNCTIONNALITY

Upon activation of this mode, all transfers of received downlink will be delayed by 50 ms. During this time, users will be notified with the pin 19 (GPIO10), it will be set to "high" for 50 ms before transferring the received downlink. Be careful, it prohibits the use of RTU mode.

6.7.5.2 EMIT_CYCLE FUNCTIONNALITY

Upon activation of this mode, all emission cycle will be indicated on the with the pin 22 (GPIO11), it will be set to "high" during the whole cycle (Tx, Rx windows and if needed repetitions). Be careful, it prohibits the use of RTU mode.



7 LORA P2P

The SX1272/73 incorporates the LoRa™ spread spectrum modem which is capable of achieving significantly longer range than existing systems based on FSK or OOK modulation.

LoRa™ Also provides significant advances in selectivity and blocking performance, further improving communication reliability. For maximum flexibility the user may decide on the spread spectrum modulation bandwidth (BW), spreading factor (SF) and error correction rate (CR). Another benefit of the spread modulation is that each spreading factor is orthogonal - thus multiple transmitted signals can occupy the same channel without interfering.

7.1 RF SPECIFICATION

ARM N8LRW: 863 - 870MHz: 44 channels of 125kHz of bandwidth, 18 channels of 250kHz of bandwidth and 1 channel of 500kHz of bandwidth.

Supply:3.3V; frequency:868.3MHz; CRC enabled; Payload length=64 bytes; Preamble Length=12 symbols; Conducted measurement.

Spreading Factor	Error Coding	Bandwidth	sensitivitydBm @ BER (10E-3)	Rejection: adjacent channel (N-1/N+1)	Rejection: alternance channel (N-2/N+2)	Blocking +/-1 MHz, +/-2 MHz, +/- 10MHz	number if channels at 14dBm	Number of channels at20dBm	Range at 20dBm in km
12	4/5-4/8	500kHz	-133				1		
11	4/5-4/8		-130						
10	4/5-4/8		-128						
9	4/5-4/8		-126	60	66	82			
8	4/5-4/8		-123						
7	4/5-4/8		-121						
12	4/5-4/8	250kHz	-137				18		20
11	4/5-4/8		-134						
10	4/5-4/8		-131						
9	4/5-4/8		-129						
8	4/5-4/8		-126						
7	4/5-4/8		-123	72	76	97			
12	4/5-4/8	125kHz	-141				44	1	25
11	4/5-4/8		-136						
10	4/5-4/8		-135						
9	4/5-4/8		-133						
8	4/5-4/8		-130	64	71	91			
7	4/5-4/8		-127						

Spreading factor can be configured from 12 to 7. It is a compromise between radio range and data rate. A spreading factor of 12 will reach higher range at a cost of a slower data rate, one of 7 will achieve higher data rate with a smaller range.



7.1.1 REVERSAL TIME

Table 21 : reversal time

BW	SF	EC	reversal Time
125kHz	12	EC=4/6	33ms
	11	EC=4/6	18ms
	10	EC=4/6	11,4ms
	9	EC=4/6	8,4ms
	8	EC=4/6	6,6ms
	7	EC=4/6	6,4ms

7.2 UART CONFIGURATION

The UART link is at 19200bps on standard, 8 bytes data, no parity, 1 stop byte, without flow control

Table 22 :UART

ATS	parameter	register value
012	UART Baudrate	1200bps=0x00, 2400bps=0x01, 4800bps=0x02, 9600bps=0x03, 19200bps=0x04, 38400bps=0x05, 57600bps=0x06,
013	UART Data bytes	7 bits = 0x07 8 bits = 0x08
014	Parity	None= 0x00, 0x02 Impair = 0x01 Pair = 0x03
015	UART Stop bytes	1 bit = 0x01 2 bits = 0x02
016	UART flow control	None=0x00 RTS/CTS=0x01
021	Number of characters before time-out	0x03

		Delay
Launch	slow (with bootloader)	3s
	fast (without bootloader)	20ms
Buffer of the UART characters		2μs
Emission characters UART >> RF	Packaging mode	3 x bytes after the last UART character received
	Endless mode	immediate after the last UART character received
Reception characters RF >> UART	Packaging mode	immediate after the last RF byte received
	Endless mode	Immediate after receiving the preamble
Radio turnaround time	(Tx-Rx or Rx-Tx)	30μs
Configuration Input	(AT commands)	Immediate after receiving '+++'
Configuration output	(AT commands)	120ms after receiving 'ATQ'
Sleep mode input	'0' on pin INT0	10ms after end of radio activity
Sleep mode output	'1' on pin INT0	10ms

7.3 SERIAL BUFFERS

The ARM-NX module has two independent buffers:

- circular reception buffer of 512 bytes
- circular emission buffer of 256 bytes

The reception buffer can memorize the beginning and the end of every finished frame at a dead time (T_f) of 3 x byte time at the UART speed.

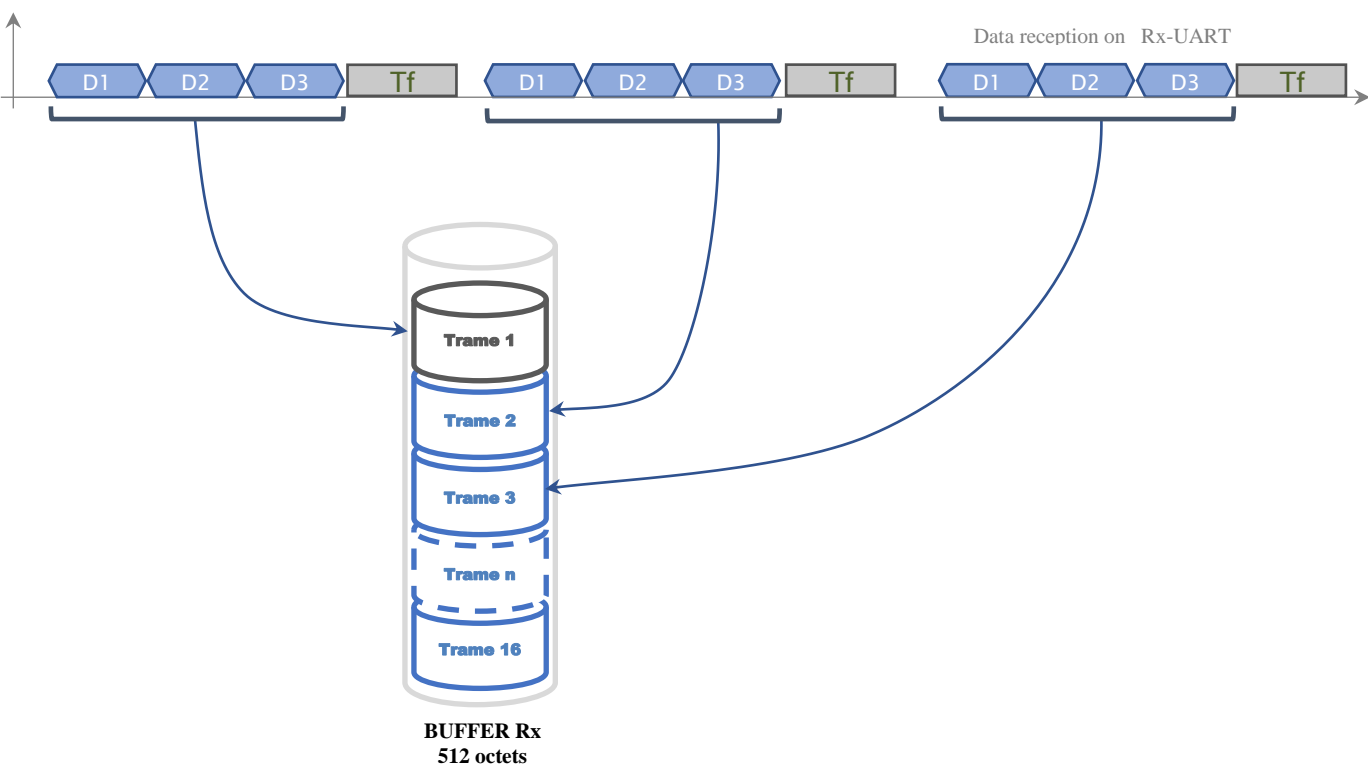

Figure 15



This mechanism enables to reproduce the flow on the distant modem by successive radio emissions. It is not done in an endless data transmission for each character received is immediately shaped to be sent by radio.

To activate this mechanism, the byte 1 of the register ATS020 must be at 1.

Table 23 : Mode octet Série / RF

ATS	bit	parameter	value	register value
020	0	_AllTraffic	1	03
	1	_TxRF_PacketMode	1	
	2	_RxRF_PacketMode	X	

7.4 TRANSPARENT (SERIAL/RF BRIDGE)

7.4.1 Configuration

To activate this mode, you need to configure:

ATS000=10 et ATM000=02

7.4.2 Functioning

In this mode, the data stored in the serial buffer are fitted to be sent by radio. The radio transmissions are done in half duplex. Many parameters can influence the delay created by the data transfer. Usually, the less data stored in modem's buffer, the shortest the delay.

To minimize communication troubles (on the UART particularly), the data rate must be the same for both communications (serial and radio). Transfer delay will be impacted by the nature of data to be sent, preamble emission phase, synchronization, control of start/end and frame errors.

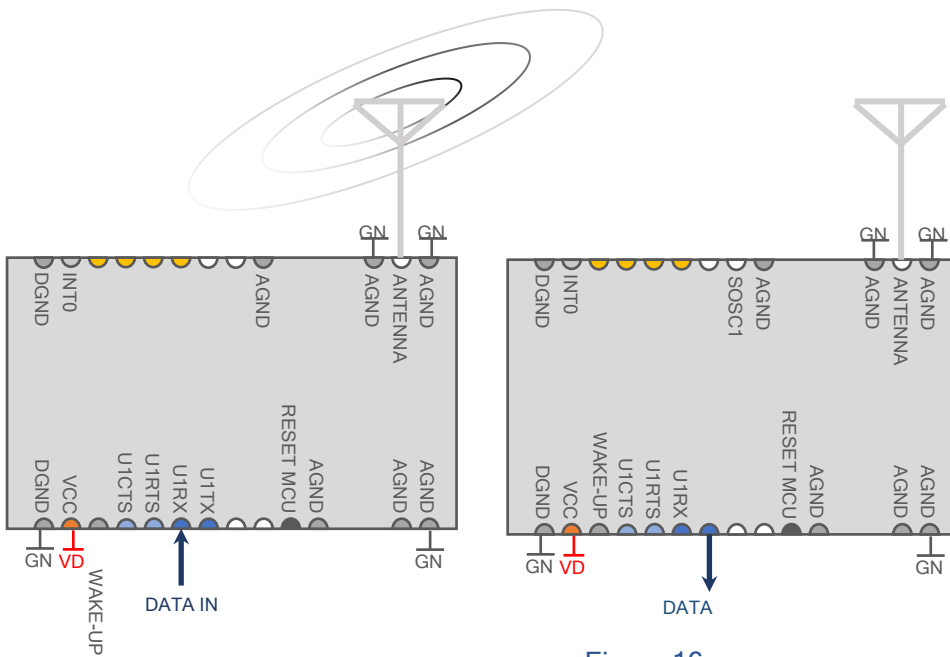
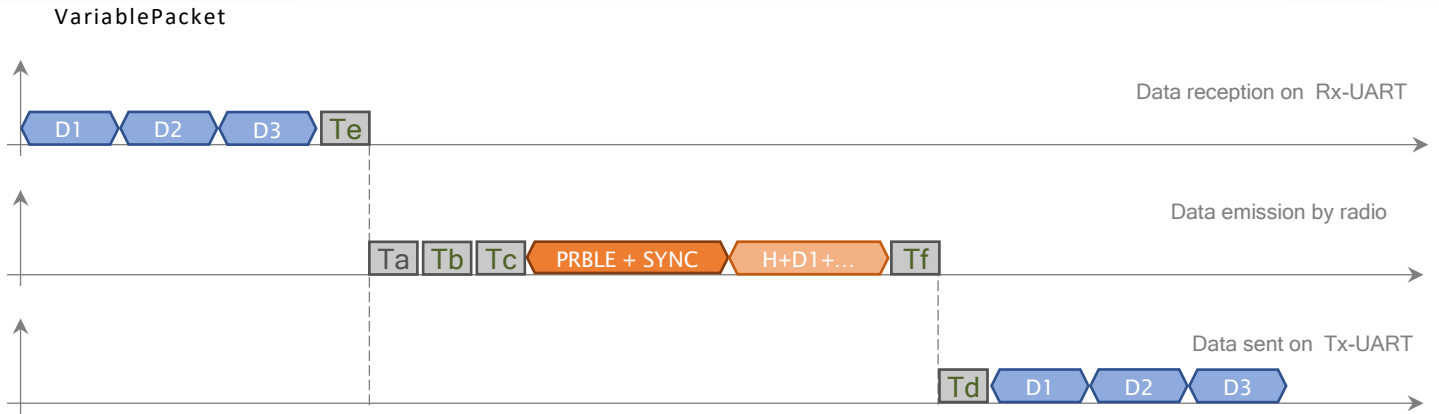

Figure 16



- Ta : If activated, time 'Listen before talk' 5ms
- Tb : If activated and justified, pseudo-random time 'Listen before talk' after a radio silence
- Tc : Time before radio emission Te : 3 x
- Td : Temps avant émission Série Tf : si CRC activé, délai CRC 16bits

Figure 17

Table 24 : Time Delay beforeTx(Td)

ATS	bit	Parameter	value	Register value
018	0:7	Time Delay beforeTx in nx10ms LSB		00
019	0:7	Time Delay beforeTx in nx10ms MSB		00



7.5 MAIN PARAMETERS

7.5.1 RF CONFIGURATION IN P2P MODE

The choice of the radio parameters depends on the radio flow and on the robustness of the link. The higher the Spreading Factor, the greater the robustness and the lower the data rate. The same reasoning also applies with the error corrector CR.

7.5.1.1 SPREADING FACTOR : ATS025

The spread spectrum LoRa™ modulation is performed by representing each bit of payload information by multiple chips of information. The rate at which the spread information is sent is referred to as the symbol rate (R_s), the ratio between the nominal symbol rate and chip rate is the spreading factor and represents the number of symbols sent per bit of information.

Note that the spreading factor, must be known in advance on both transmit and receive sides of the link as different spreading factors are orthogonal to each other. Note also the resulting signal to noise ratio (SNR) required at the receiver input. It is the capability to receive signals with negative SNR that increases the sensitivity, so link budget and range, of the LoRa receiver.

Spreading Factor 6

SF = 6 is a special use case for the highest data rate transmission possible with the LoRa modem. To this end several settings must be activated in the SX1272/73 registers when it is in use:

ATS080 : b2=1

ATS027=06

The payload length used in ATS024 should be the same in the transmitter and the receiver.

7.5.1.2 CODING RATE : ATS026

To further improve the robustness of the link the LoRa™ modem employs cyclic error coding to perform forward error detection and correction.

Forward error correction is particularly efficient in improving the reliability of the link in the presence of interference. So that the coding rate (and so robustness to interference) can be changed in response to channel conditions - the coding rate can optionally be included in the packet header for use by the receiver.

7.5.1.3 BANDWIDTH : ATS027

An increase in signal bandwidth permits the use of a higher effective data rate, thus reducing transmission time at the expense of reduced sensitivity improvement. There are of course regulatory constraints in most countries on the permissible occupied bandwidth. Contrary to the FSK modem, which is described in terms of the single sideband bandwidth, the LoRa™ modem bandwidth refers to the double sideband bandwidth.

NO LOW DR OPTIMIZED (ATS079, b7 = 0, b7 = 0) for low flow rates with SF values of 11 and 12 with BW = 125k
Relationship between Radio flow (DR: data rate, R_s : symbol rate) and bandwidth: BW

$$R_s = BW / (2^{SF}) ; DR = SF * (BW / 2^{SF}) * CR$$



Table 25 :DataRate Equivalent

DR en bps		BW=125kHz					
CR \ SF	12	11	10	9	8	7	
4/5	292	537	976	1758	3125	5468	
4/6	244	447	814	1465	2604	4557	
4/7	209	383	698	1255	2232	3906	
4/8	183	335	610	1100	1953	3418	

		BW=250kHz					
CR \ SF	12	11	10	9	8	7	
4/5	584	1074	1952	3516	6250	10936	
4/6	488	894	1628	2930	5208	9114	
4/7	418	766	1396	2510	4464	7812	
4/8	366	670	1220	2200	3906	6836	

7.5.2 Low Data Rate Optimization

Given the potentially long duration of the packet at high spreading factors the option is given to improve the robustness of the transmission to variations in frequency over the duration of the packet transmission and reception. The bit *LowDataRateOptimize* increases the robustness of the LoRa link at these low effective data rates, its use is mandated with spreading factors of 11 and 12 at 125 kHz bandwidth.

ATS	bit	parameter	value	register value
079	7	BYTE low datarate optimizer:1;	0: ON; 1: OFF	

7.6 LORA_{TM} PACKET STRUCTURE

The LoRa_{TM} modem employs two types of packet format, fixed packet and variable packet. The variable packet includes a short LoRa-header that contains information about the number of bytes, coding rate and whether a CRC is used in the packet. The packet format is shown in the following figure.

The LoRa_{TM} packet comprises three elements:

- A preamble.
- An optional LoRa-header.
- The data LoRa-payload.

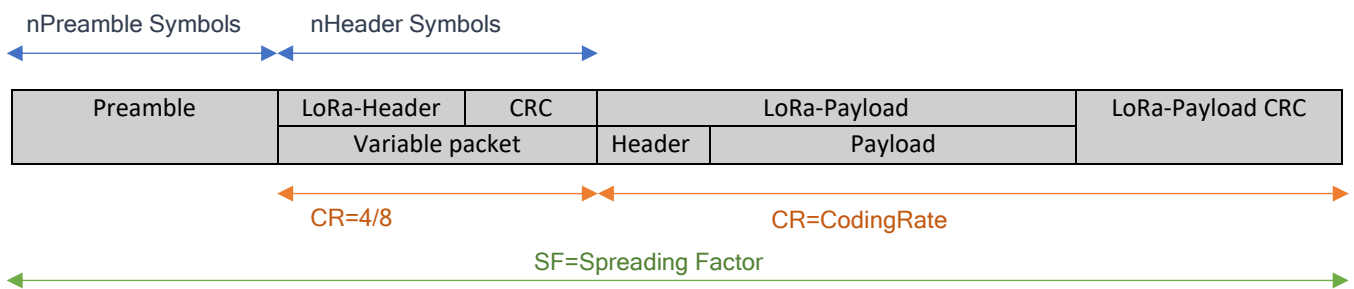

Figure 18

7.6.1 Preamble

The preamble is used to synchronize receiver with the incoming data flow. By default the packet is configured with a 12 symbol long sequence. This is a programmable variable so the preamble length may be extended, for example in the interest of reducing to receiver duty cycle in receive intensive applications. The transmitted preamble length may be changed by setting the registers *ATS030* and *ATS031* from 6 to 65535, yielding total preamble lengths of 6 + 4 to 65535 + 4 symbols, once the fixed overhead of the preamble data is considered. This permits the transmission of near arbitrarily long preamble sequences.

The receiver undertakes a preamble detection process that periodically restarts. For this reason the preamble length should be configured identical to the transmitter preamble length. Where the preamble length is not known, or can vary, the maximum preamble length should be programmed on the receiver side.

7.6.2 Variable packet LoRa-Header Mode

This is the default mode of operation. Here the header provides information on the payload, namely:

- The payload length in bytes.
- The forward error correction code rate.
- The presence of an optional 16-bits CRC for the payload.

The header is transmitted with maximum error correction code (4/8). It also has its own CRC to allow the receiver to discard invalid headers.

7.6.3 Fixed packet LoRa-Header Mode



In certain scenarios, where the payload, coding rate and CRC presence are fixed or known in advance, it may be advantageous to reduce transmission time by invoking implicit header mode. In this mode the header is removed from the packet. In this case the payload length, error coding rate and presence of the payload CRC must be manually configured on both sides of the radio link.

Note that with SF = 6 selected implicit header mode is the only mode of operation possible.

7.6.4 SyncWord

In LoRaWAN, for private networks: SyncWord = 0x12

In LoRaWAN, for public networks: SyncWord = 0x34

In order to avoid possible collisions, it is possible to change SyncWord.

7.6.5 Low Data Rate Optimization

Given the potentially long duration of the packet at high spreading factors the option is given to improve the robustness of the transmission to variations in frequency over the duration of the packet transmission and reception. The bit *LowDataRateOptimize* increases the robustness of the LoRa link at these low effective data rates, its use is mandated with spreading factors of 11 and 12 at 125 kHz bandwidth.

7.6.6 Lora-Payload

The LoRa-payload includes the user header and the user payload.

The packet LoRa-payload is a variable-length field that contains the actual data coded at the error rate either as specified in the header in variable packet mode or in fixed packet mode. An optional CRC may be appended.

7.6.6.1 HEADER

The header choice for a long or short enables to privilege either the routing of the radio messages, or the transmission delays. Header long (7 bytes) or short (1 byte) (ATS080, bit0=1 et bit 1: long = 1, short = 0).

Long Header : 7 bytes

1 Byte : Longueur trame

1 byte : Protocole :

NONE_PROTOCOL=0x00,

UART_RF_BRIDGE_PROTOCOL=0x01,

AT_CMD_PROTOCOL=0x02,

PING_PROTOCOL=0x03,

PONG_PROTOCOL=0x04,

ACW_CONF_PROTOCOL=0x09,

UNKNOWN_PROTOCOL=0xFF,

1 byte : Flag :

Bit 0 : Repeated frame

Bit 1 : Must be repeated

2 bytes : Source Address

2 bytes : Destination Address

Short Header : 2 bytes

1 Byte : Longueur trame

1 byte : Protocole :

NONE_PROTOCOL=0x00,
 UART_RF_BRIDGE_PROTOCOL=0x01,
 AT_CMD_PROTOCOL=0x02,
 PING_PROTOCOL=0x03,
 PONG_PROTOCOL=0x04,
 ACW_CONF_PROTOCOL=0x09,
 UNKNOWN_PROTOCOL=0xFF,

7.6.7 Address

In the Header long mode (bit 1, ATS080), the radio protocol inserts the expeditor and destination addresses in the header so that the radio frames are addressed. These data's enables the distant modems (in long header mode) to filter the messages or not.

Table 26 : Header

Header

ATS	bit	parameter	value	register value
080	0	AttachHeaderOn	0:no header 1:with header	01
	1	LongHeaderOn :1	0:short 1:Long	
	2	FixedPacketSizeOn :1	0:variable 1:fixed	
	3	InfinitePacketOn :1	0: Finite 1:Infinite	
	4	AcceptBroadcastOn :1	0	
	5	AcceptAllRx :1	0	

The addresses can then be parametered in the registers:

- ATS064/S065: sender address (default 0x00: broadcast address to address the message of all sender)
- ATS066/ATS067: destination address (default 0xFF: broadcast address to address the message to all recipients)

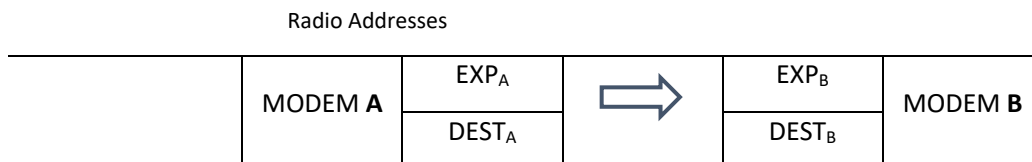

Filter rules (in reception) of the message sent the modem A and received by the modem B.

7.6.8 User payload

Radio data formatting includes the following parts:
 Payload (max size of 120 bytes in packetized mode)
 Footer (CRC16 en option) (bit 3, ATS079, CRC = 1, No CRC = 0)

7.7 LBT (LISTEN BEFORE TALK)

The LBT technique aims at improving the radio-electric spectral efficiency of the 863-870 MHz band. When a modem needs to emit, it listens to the network to see if another emission is being done at the same time (Presence or not of a magnitude signal bigger or equal to the detection limit). If it is the case, it will wait for a pseudo random time between 1 to 5 ms and re-listens, otherwise it sends straight away.

Equipment using LBT are not limited to a cyclic report. If the LBT is not used, a cyclic report must be done according to the ERC 70-03 [2] recommendation.

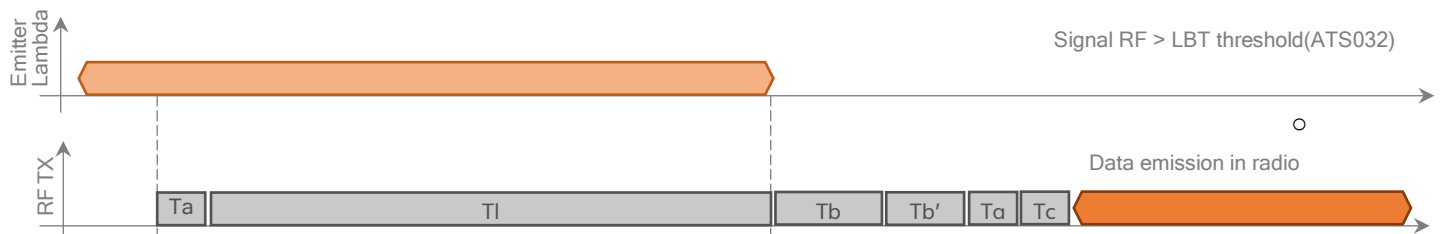

Ta : Time 'Listen before talk' 5ms

TI : Listening period

Tb : Pseudo random time 'Listen before talk'

Tb' : Additional time (ATS056 from 0 to 255ms)

Tc : Remaining time before radio emission (ATS017)

Figure 19

activate the LBT, use ATS079 b4, the LBT threshold will be adjusted via ATS032. Its value is decimal signed.

The LBT threshold is defined as the received signal level above which the channel is considered as busy or available. If the received signal is below the LBT threshold, then the channel is available.

Exemple:

```
ATM000=02 P2P Mode
ATS002=12 Channel A
ATS079=11 LBT
ATS032=-100 LBT Threshold
```

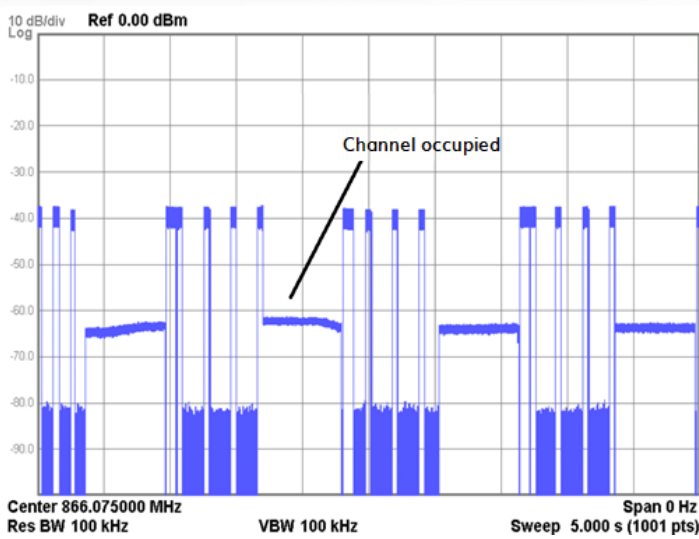

Figure 20

7.8 LBT&AFA (ADAPTATIVE FREQUENCY AGILITY)

AFA is a technique used to avoid transmission in channels that are already busy. The radio transmitter periodically monitors the channels in the radio environment and stores busy channels. On the basis of this information, the transmitter selects a free channel to avoid interference.

The LBT & AFA technique is primarily designed to improve the efficient use of the allocated radio spectrum of the 863-870 MHz band

Equipment using the LBT is not limited to a duty cycle limitation. If LBT is not used, a duty cycle should be applied according to ERC Recommendation 70-03 [2].

Use ATS079 b5 to enable AFA. LBT is inseparable from AFA. It is therefore necessary to adjust the LBT threshold via ATS032. Channel A is set by ATS002 and the second channel is programmed by ATS062.

Exemple :

ATM000=02 P2P Mode
 ATS002=01 Channel A
 ATS062=12 Channel B
 ATS079=31 LBT+AFA Mode
 ATS032=-100 LBT thresholf=-100dBm

7.9 SNIFF MODE

To minimize consumption, the receiver is operated on a limited duty cycle. Here the receiver wakes periodically with a period defined by the length of the preamble transmitted by the Transmitter.

Upon finding, receiving and detecting the transmitted preamble, the receiver ‘wakes’ into receive mode and processes the received information. In the hypothetical application we consider here, however, such events are infrequent. The device, instead, spends the majority of its time cycling from sleep to receiver mode and returning as quickly as possible to sleep to minimise energy consumption. The channel activity detection CAD process is used in this mode to detect the preamble which could be below the noise floor. The preamble length should be longer than the sniff period.

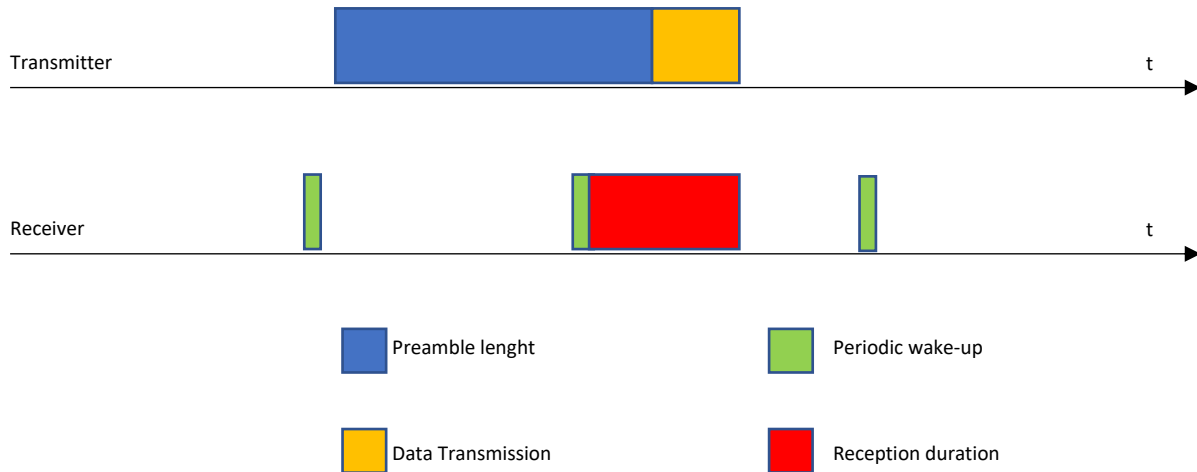

Figure 21

“Channel Activity Detection” (CAD) because LoRa can function below the noise floor the LoRa modem includes a method of detecting the presence of preamble at the same modulation settings as the receiver. This permits accurate evaluation of whether the Source should remain ‘awake’ and continue the demodulation process.”

Registers used:

Preamble Length:	ATS030-ATS031 (b0-b15)
Sniff Period:	ATS007 (b0-b7)
Rx TimeOut:	ATS006 (b0-b7)
Low Power Mode:	ATM01 (b0)
Sniff Mode:	ATS080 (b7)

Exemple:

ATM000=2	P2P Mode
ATS079=81	LORA +Low datarate optimized
ATS080=80	Sniff mode
ATS006=14	Rx Timeout
ATS007=32	sniff period
ATS030=32	preamble length
ATM001=01	low power mode

7.10 REPEATER

A repeater allows users to increase the radio link to ensure robust communication.

7.10.1 Unidirectional configuration:

The frames received by the repeater on the frequency f_1 are retransmitted on the frequency f_2 . In this way stations A and B seem to dialogue "live". Repeater storage time is minimized to avoid collision problems. However, the dwell time is multiplied by 2.

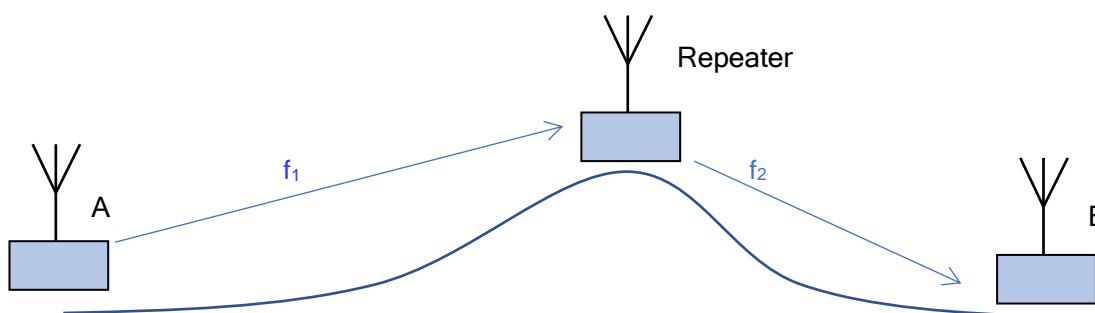

Figure 22

Registers used:

Repeater Mode : ATS079, ATS002, ATS062

7.10.2 Bidirectional configuration:

In the bidirectional configuration, station A can communicate to station B, and vice versa. In this configuration, the repeater is able to listen on the 2 channels used by the stations. It is therefore advisable to increase the preamble duration to ensure a good reception of the repeater. The stations and the repeater must have the same preamble length. To use bidirectionality, activate the AFA function.

Registers used:

Stations: **ATS079, ATS030, ATS006, ATS002, ATS062**

Repeater: **ATS079, ATS030, ATS006, ATS062, ATS002**

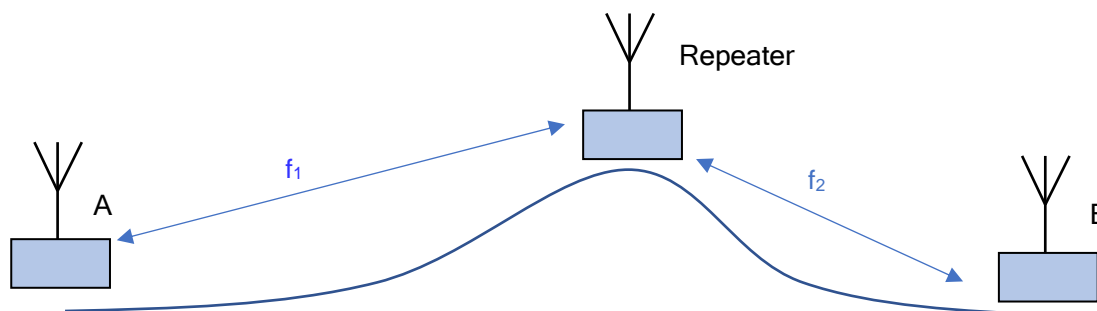

Figure 23



7.11 DESCRIPTION OF THE REGISTERS

Table 27 : Registers

REGISTER	DESIGNATION	DESIGNATION VALUES	DEFAULT VALUES	READ/WRITE
S000	Application1	OPERATING_MODE_PING PONG Master = 0x00 OPERATING_MODE_PING PONG Slave = 0x01, OPERATING_MODE_Permanent Rx with RSSI = 0x02, OPERATING_MODE_PURE CARRIER EMISSION= 0x04, OPERATING_MODE_Modulation Random=0x07, OPERATING_MODE_Transient=0x08; =10 mode transparent OPERATING_MODE_OTAA = 0x11,	0x10	R/W
S002	Radio_Channel A		0x012	R/W
S003				
S004	Radio_OutputPowerEmission		0x07	
S005	Radio_AddGain(OFFSET?)		0x00	NC
S006	RxPacketTimeout (LoRa) in 100ms (pour éviter blocage)		0x32	NC
S007	TimeBetweenSniff in 10ms		0x00	NC
S008	RF Datarate Only for 2GFSK modulation	1.2kbps: 0x01, 2.4kbps: 0x02, 4.8kbps: 0x03, 9.6kbps: 0x04, 19.2kbps: 0x05, 38.4kbps: 0x06, 57.6kbps: 0x07	0x01	R/W
S012	Serial_Baudrate	1200=0x00, 2400=0x01, 4800=0x02, 9600=0x03, 19200=0x04, 38400=0x05, 57600=0x06, 115200=0x07, 230400=0x08,	0x03	R/W
S013	Serial_Databit	DATABITS_7=0x07, DATABITS_8=0x08,	0x08	R/W
S014	Serial_Parity	PARITY_UNDEFINED, PARITY_ODD_DISABLE=0x00, PARITY_ODD_ENABLE=0x01, PARITY_EVEN_DISABLE=0x02, PARITY_EVEN_ENABLE=0x03,	0x02	R/W
S015	Serial_Stopbit	STOPBIT_1=0x01, STOPBIT_2=0x02,	0x01	R/W
S017	TX DelayAfterTx;	Kdelay 0:6; Fdelay b7 Si b7=0 delay=0+10ms*Kdelay Si b7=1 delay=TxSize+10ms*Kdelay	0x00	NC
S018	Time Delay beforeTx in nx10ms LSB		0x0	NC
S019	Time Delay beforeTx in nx10ms MSB		0x0	NC
S020	HFSS sequence of channels	00 to 0F	0x00	NC
S021	Serial Timeout in char		0x0	NC
S022	Radio_HFSS period;		0x04	NC
S023	LBT_RSSI_Time (en millisecondes)	5 (notation décimale)	5	R/W
S024	BYTE PayloadLength; en dec		0x10	NC
S025	Signal Bandwidth (LoRa)	125 kHz = 0x00, 250 kHz = 0x01, 500 kHz = 0x02	0x00	R/W



S026	Error Coding (LoRa)	4/5 = 0x01, 4/6 = 0x02, 4/7 = 0x03, 4/8 = 0x04	0x02	R/W
S027	Spreading Factor (LoRa)	64 chips/symbol = 0x06, 128 chips/symbol = 0x07, 256 chips/symbol = 0x08, 512 chips/symbol = 0x09, 1024 chips/symbol = 0x0A, 2048 chips/symbol = 0x0B, 4096 chips/symbol = 0x0C	0x07	R/W
S028	Wake Up Source power	0x80 sur pins WP 0x40 sur UART	0x00	NC
S029	Sleep Mode in 10ms	b1 de ATM6 à 0, sinon en ms	0x00	NC
S030	PreambleLength en dec		0x08	NC
S031	PreambleLength; en dec		0x08	NC
S032	Radio_RSSIlevel for LBT en dec	(notation décimale)	-75	NC
S033	LocalFrameRxListenTime	Enables listening in Rx mode after transmission of the local frame. If a DL returns (by a repeater), it will be received and retransmitted on the serial link. If a DL is received, the LoRaWAN cycle will not have places. Adjustment in steps of 100ms. Value 0 = No listening.	0x00	W
		Adjustment in steps of 100ms. Value 0 = No listening		
S062	Radio_Channel B		0x026	R/W
S063				
S064	Local Address LSB		0x00	NC
S065	Local Address MSB		0x00	NC
S066	Dest address LSB		0x00	NC
S067	Dest address MSB		0x00	NC
S069	RepeatMode_Settings	unsigned char _Enabled:1; unsigned char _undefined:7;	0x00	R/W
S078	Sync world		0x12(en décimal)	NC
S079	Flags LoRa/Fsk	-LoRaOn:1; // 1 : LoRa ; 0 : Fsk -AfcOn:1; // Fsk -HFSS:1; -CrcOn:1; -LbtOn:1: activation du mode Listen Before Talk -AfaOn:1: activation du mode AFA -RepeatModeOn:1; // LoRa + Fsk : -Low datarate optimizer:1; 0:ON; 1: OFF	0x01	R/W
S080	RadioParameters	-AttachHeaderOn:1; (0 : sans header ; 1 : avec header) -LongHeaderOn:1; (0 : header court ; 1 : header long) -FixedPacketSizeOn:1; (0 : paquet variable ; 1 : paquet fixe) -InfinitePacketOn:1; (bit 3) -AcceptBroadcastOn:1 -AcceptAllRx:1; -UseDataEncryption:1; -Sniff on:1;	0x01	R/W
S081		BYTE AddrRSSIOnSerial:1; b0 BYTE Rssi in ascii:1; Hex:0; b1 BYTE _PushHeaderInDataFifo; b2	0x00	NC

7.12 RADIO CHANNELS

The table below allows users to select channels to get the longest possible range or to avoid LoRaWAN channels.



Table 28 : Lora P2P Channels

Frequency in MHz	New Channel		BW		
	ATS002/ATS003=F		ATS25=0	ATS25=1	ATS25=2
	0 in HEX		125kHz	250kHz	500kHz
863,125	1	1	14dBm ou 6,2dBm/100kHz		
863,25	2	2	14dBm ou 6,2dBm/100kHz	14dBm	
863,375	3	3	14dBm ou 6,2dBm/100kHz		
863,5	4	4	14dBm ou 6,2dBm/100kHz	14dBm	
863,625	5	5	14dBm ou 6,2dBm/100kHz		
863,75	6	6	14dBm ou 6,2dBm/100kHz	14dBm	
863,875	7	7	14dBm ou 6,2dBm/100kHz		
864	8	8	14dBm ou 6,2dBm/100kHz	14dBm	
864,125	9	9	14dBm ou 6,2dBm/100kHz		
864,25	10	A	14dBm ou 6,2dBm/100kHz	14dBm	
864,375	11	B	14dBm ou 6,2dBm/100kHz		
864,5	12	C	14dBm ou 6,2dBm/100kHz	14dBm	
864,625	13	D	14dBm ou 6,2dBm/100kHz		
864,75	14	E	14dBm ou 6,2dBm/100kHz	14dBm	
864,875	15	F	14dBm ou 6,2dBm/100kHz		
865,1125	16	10	14dBm ou 6,2dBm/100kHz		
865,25	17	11	14dBm ou 6,2dBm/100kHz	14dBm	
865,3875	18	12	14dBm ou 6,2dBm/100kHz		25mW
865,525	19	13	14dBm ou 6,2dBm/100kHz	14dBm	
865,6625	20	14	14dBm ou 6,2dBm/100kHz		
865,8	21	15	14dBm ou 6,2dBm/100kHz	14dBm	
865,9375	22	16	14dBm ou 6,2dBm/100kHz		25mW
866,075	23	17	14dBm ou 6,2dBm/100kHz	14dBm	
866,2125	24	18	14dBm ou 6,2dBm/100kHz		
866,35	25	19	14dBm ou 6,2dBm/100kHz	14dBm	
866,4875	26	1A	14dBm ou 6,2dBm/100kHz		25mW
866,625	27	1B	14dBm ou 6,2dBm/100kHz	14dBm	
866,7625	28	1C	14dBm ou 6,2dBm/100kHz		
866,9	29	1D	14dBm ou 6,2dBm/100kHz	14dBm	
867,0375	30	1E	14dBm ou 6,2dBm/100kHz		25mW
867,175	31	1F	14dBm ou 6,2dBm/100kHz	14dBm	
867,3125	32	20	14dBm ou 6,2dBm/100kHz		
867,45	33	21	14dBm ou 6,2dBm/100kHz	14dBm	
867,5875	34	22	14dBm ou 6,2dBm/100kHz		25mW
867,725	35	23	14dBm ou 6,2dBm/100kHz	14dBm	
867,8625	36	24	14dBm ou 6,2dBm/100kHz		
868,1625	37	25	14dBm		
868,3	38	26	14dBm	14dBm	14dBm
868,4375	39	27	14dBm		



868,8125	40	28	14dBm		
868,95	41	29	14dBm	14dBm	
869,0875	42	2A	14dBm		
869,525	43	2B	20dBm		
869,85	44	2C	14dBm	14dBm	

7.13 TEST MODE

It is possible to switch the modem to permanent test mode without using ATT CMD. If the module restarts, it will initialize in the desired test mode. To do this, one of the following registers must be configured:

Table 29 : Operating Mode

Main operating mode			
ATS	bit	Paramètre	valeur registre
000	0:7	Main test mode	Mode test : 00 : pingpong master 01 : pingpong slave 02 : Continuous reception 04 : Emission pure carrier 07 : Continuous modulation emission 0A : RSSI value on current channel

Test modes allow users to test the radio link of products, but also to pass standardization

7.13.1 PING PONG MODE:

Configuration:

Master: ATT00 or ATS000=00

Slave: ATT01 or ATS000=01

Example

MODEM A

ATM000=2 P2P mode
 ATS002=03 Channel
 ATS025=00 BW=125kHz
 ATS026=04 CR=4/8
 ATS027=0A SF=10
 ATS000=00 PingPong Master
 ATR Reset

MODEM B

ATM000=2 P2P mode
 ATS002=03 Channel
 ATS025=00 BW=125kHz
 ATS026=04 CR=4/8
 ATS027=0A SF=10
 ATS000=01 PingPong Slave
 ATR Reset

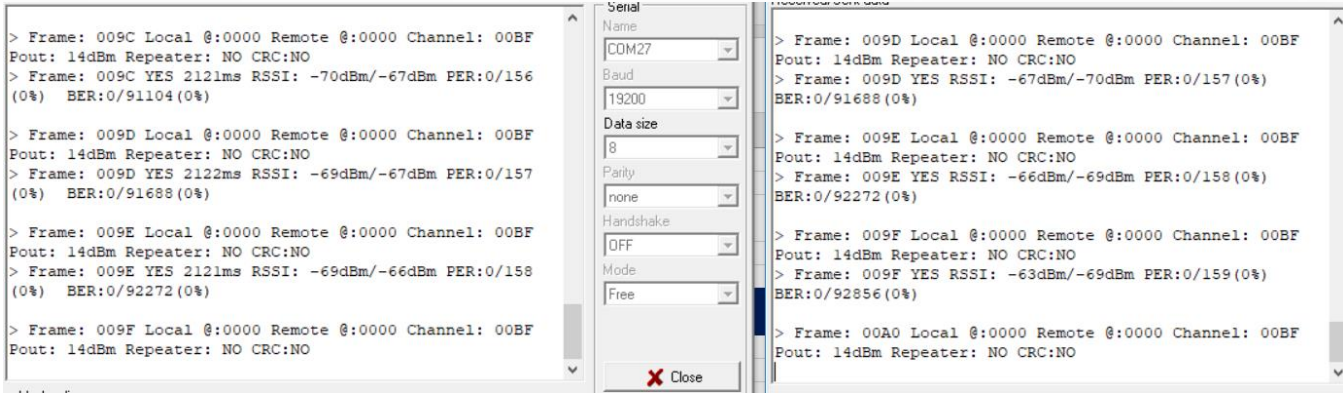

Figure 24

Ping Pong mode is used to evaluate the RF link of the products by displaying the RSSI values of the Master and the Slave. PER and BER are also found to measure the error rate.

7.13.2 RSSI READING: ATT0A/ATT02 OR ATS000=0A/ATS000=02

Other modes very useful to know the quality of the signal. Reading RSSI allows the user to know the quality of the RF link of his network. Two solutions can be used. Either we measure the level of all the signals by using ATT0A, or we measure only the level of the useful signal by using ATT02.

Example:

ATM000=2
ATT0A Or ATS000=0A

```

ATM005
M005=0A RAM 0A EEP
ATM6
M006=00 RAM 00 EEP
ATM1
M001=00 RAM 00 EEP
ATS025
S025=00
ATS026
S026=02
ATS027
S027=0C
ATS079
S079=81
ATT02

Modem is in continuous Rx
1233212hjghghghfgh | Status RSSI: -85dBm
1233212hjghghghfgh | Status RSSI: -85dBm

Test mode stopped

ATT0A

Entering in spectrum-analyser mode
Channel: 0012 Avg: -120dBm Max: -120dBm
Channel: 0012 Avg: -121dBm Max: -119dBm
Channel: 0012 Avg: -121dBm Max: -118dBm
Channel: 0012 Avg: -121dBm Max: -119dBm
Channel: 0012 Avg: -82dBm Max: -80dBm
Channel: 0012 Avg: -82dBm Max: -80dBm
Channel: 0012 Avg: -81dBm Max: -80dBm
Channel: 0012 Avg: -81dBm Max: -80dBm

```

Figure 25

7.13.3 PUR CARRIER MODE: ATT04 or ATS000=04

This mode makes it possible to measure the level of the transmitted signal. To be able to use co mode, it is strongly to switch to FSK mode and choose the FSK channel and not the LORA channel.

Example



<i>ATMM000=02 RAM 02 EEP</i>	<i>P2P mode</i>
<i>ATS002=0003</i>	<i>channel 03</i>
<i>ATS079=00</i>	<i>FSK modulation</i>
<i>ATT04 or ATS000=04</i>	<i>Pure carrier mode</i>

7.13.4 CONTINUOUS MODULATION: ATT07 or ATS000=07

Mode for measuring the modulation bandwidth

Example

<i>ATM000=02 RAM 02 EEP</i>	<i>P2P mode</i>
<i>ATS002=0003</i>	<i>channel 03</i>
<i>ATS079=01</i>	<i>LORA modulation</i>
<i>ATT07 or ATS000=07</i>	<i>Continuous modulation mode</i>

7.13.5 TRANSIENT MODE: ATT08 or ATS000=08

Mode for measuring the transient.

Example :

<i>ATM000=02</i>	<i>P2P Mode</i>
<i>ATS002=12</i>	<i>LoRa channel</i>
<i>ATS025=00</i>	<i>Bandwidth</i>
<i>ATS026=02</i>	<i>Error Coding</i>
<i>ATS027=0A</i>	<i>Spreading Factor</i>
<i>ATS079=01</i>	<i>LoRa modulation</i>
<i>ATS000=08</i>	<i>Transient Mode</i>



7.14 EXAMPLE

7.14.1 RX MODE WITH RSSI READING

Modem A		Modem B	
ATM000=02	Local mode	ATM000=02	Local mode
ATS079=01	LORA modulation	ATS079=01	LORA modulation
ATS081=03	RSSI	ATS081=03	RSSI
ATMS	SAVE	ATMS	SAVE
ATR	EXIT CMD MODE	ATR	EXIT CMD MDE

Figure 26

7.14.2 ADDRESS MODE

7.14.2.1 MODEM A ADDRESS ≠ MODEM B ADDRESS

Modem A		Modem B	
ATM000=02		ATM000=02	
ATS080=03	Address mode	ATS080=03	Address mode
ATS064=0010	sender address	ATS064=0009	sender address
ATS066=0005	destination address	ATS066=0004	destination address
ATMS		ATMS	

Figure 27

Modem A does not see Modem B messages, and vice versa, because Modem A address is different from Modem B address.



7.14.2.2 ADDRESS OF A ≠ ADDRESS OF B, BUT B IS IN "ACCEPTALLRX"

MODEM A		MODEM B
ATM000=02	Local mode	ATM000=02
ATS080=03	ATS080=33	"AcceptAllRx", Listen to all (b4) without filtering 'b5)
ATS064=0010	ATS064=0009	sender address
ATS066=0005	ATS066=0004	destination address

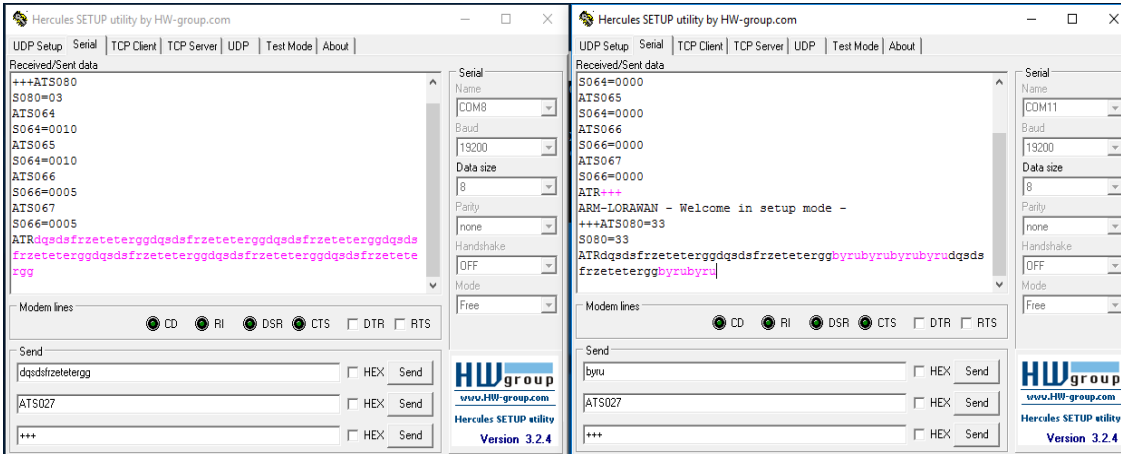

Figure 28

Modem B receives data from Modem A
Modem A can not receive data from Modem B

7.14.2.3 ALLRX VS BROADCAST (1)

MODEM A		MODEM B	
ATM000=02		ATM000=02	
ATS080=13	A listens to everyone with filtering (if ATS066 of B = FFFF)	ATS080=23	Addressed mode. B listens to everyone without filtering
ATS064=0010	Local Address	ATS064=0000	Local Address
ATS066=0005	Destination Adresse	ATS066=0000	Destination Adresse
ATMS		ATMS	
ATR		ATR	

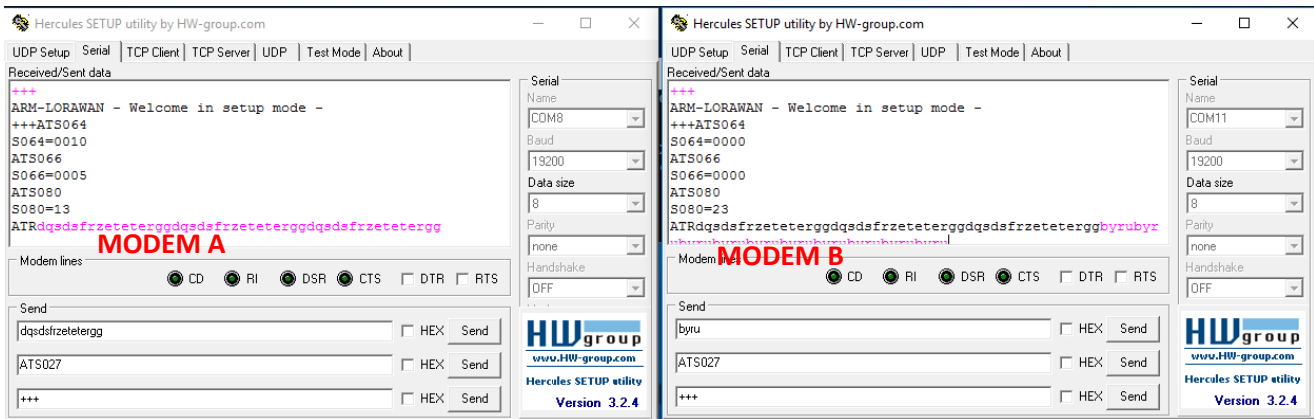

Figure 29

Modem B receives data from A because B is in All Rx without filtering, A is in Broadcast, but does not receive those of B because ATS066 (of B) ≠ FFFF

7.14.2.4 ALLRX VS BROADCAST (2)

ATS080=13	In Broadcast, A listens to everyone with filtering if ATS066 (of B) = FFFF	ATS080=23	Adressed mode in All Rx
ATS064=0010	Local address local	ATS064=0000	Local Address
ATS066=0005	Destination Address	ATS066=FFFF	Destination Address
ATM000=02		ATM000=02	
ATMS		ATMS	
ATR		ATR	

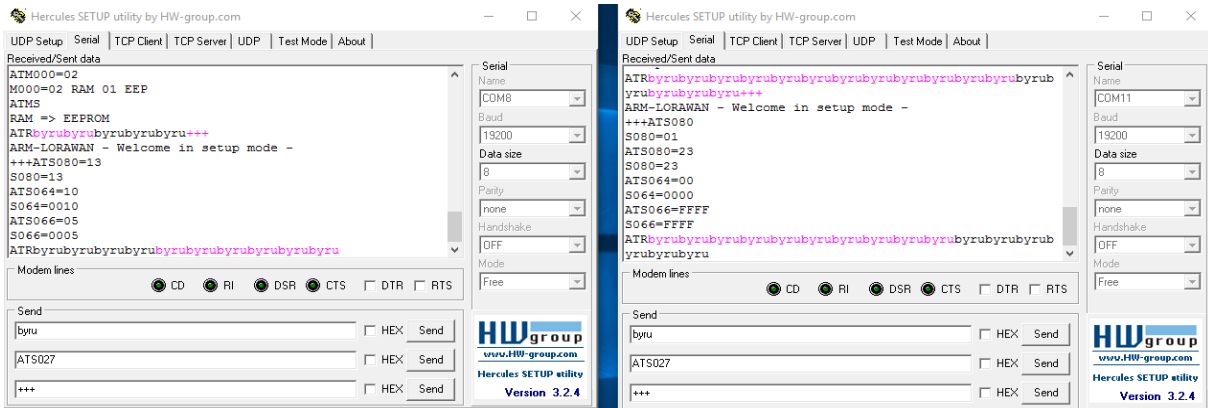

Figure 30

The Modem B (in All Rx) receives the data of A, and A (in broadcast) receives those of B because ATS066 (of B) = FFFF

7.14.3 REPEATER IN BIDIRECTIONAL CONFIGURATION+ADDRESS MODE

Modem A	Repeater	Modem B
ATM000=02 P2P mode	ATM000=02 P2P mode	ATM000=02 P2P mode
ATS079=01 LoRa modulation	ATS079=61 Repeater+AFA	ATS079=01 LoRa modulation
ATS002=03 channel A	ATS032=-50 LBT threshold	ATS002=17 channel B
ATS0062=17 channel B	ATS002=03 channel A	ATS0062=03 channel A
ATS030=16 Préamable lenght	ATS0062=17 channel B	ATS030=16 Préamable lenght
ATS006=32 RxTimeOut	ATS030=16 Préamable lenght	ATS006=32 RxTimeOut
ATS080=33 long header+broadcast	ATS006=08 RxTimeOut	ATS080=33 long header+broadcast
ATS064=0010 local address	ATS080=03 long header	ATS064=0010 local address
ATS066=FFFF destination address	ATS064=0005 local address	ATS066=FFFF destination address
ATR	ATS066=0010 destination address	ATR
	ATR	

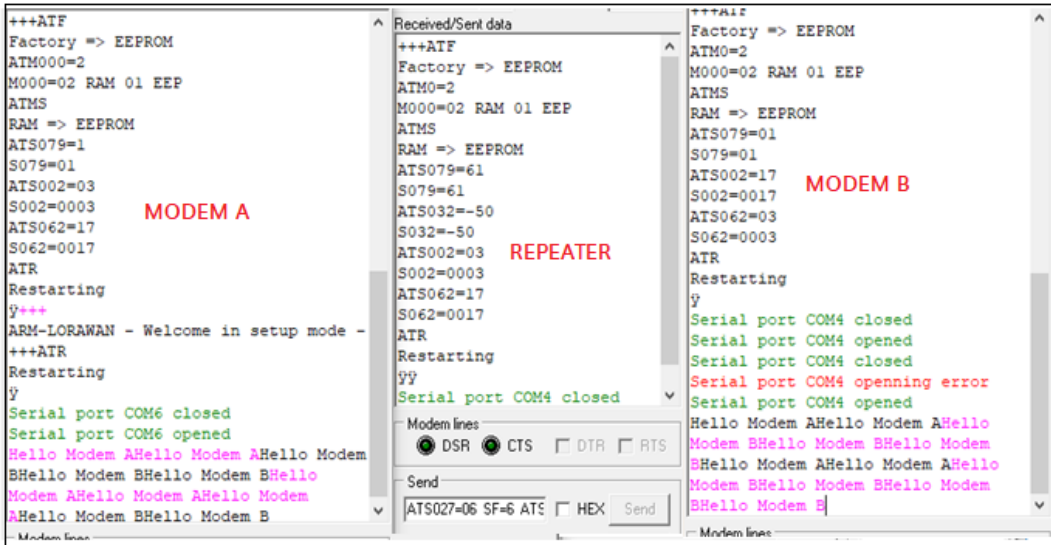

Figure 31

REPEATER LORA M2M / LORAWAN

The module makes it possible to increase the radio range the set of products in deep indoor or remote from a base station. If the repeater is configured in sniff mode, its consumption will be low enough to be powered by batteries.

